



## BE IN CONTROL.

- Simple installation.
- Enables optimised control of the climate unit.
- Control the climate unit using degree minute calculation.
- Clear display of the heat pump's and heating system's essential temperatures.
- SMO 20 has automatic legionella control.
- With a height of only 1500 mm, VPB 200/70, together with SMO 20 and any NIBE outdoor air heat pump F2030 or F2040, makes an excellent combination in the event of low ceilings.
- NIBE Uplink™ in combination with the internet gives a quick overview and the present status of the installation and comfort in the home regardless of the location of the user.

### **NIBE SMO 20**

SMO 20 is a modern, simple control module that, together with a NIBE air/water heat pump, a water heater and an extra step-controlled addition, creates a complete installation.

Outdoor sensor, room sensor and three temperature sensors are included. F2040/F2300 works with floating condensing against the heating system and prioritises hot water charging via the reversing valve.

# GOOD TO KNOW ABOUT NIBE™ SMO 20

## Principle of operation

SMO 20 can be connected together with other products from NIBE in several different ways, some of which are shown below (accessories may be required). Further option information is available at [www.nibe.se/docking](http://www.nibe.se/docking) and in the respective assembly instructions for the accessories used. See the last page of this product sheet for the list of the accessories that can be used with SMO 20.

Installations with SMO 20 can produce heating and hot water. On cold days of the year when the access to energy from the air is reduced the additional heating can compensate and help to produce heat. The additional heating is also good to have as assistance if the heat pump ends up outside its working range or if it has been blocked for any reason.

## System diagram for a compatible air/water heat pump together with SMO 20 and electric heater before reversing valve for hot water (floating condensing)

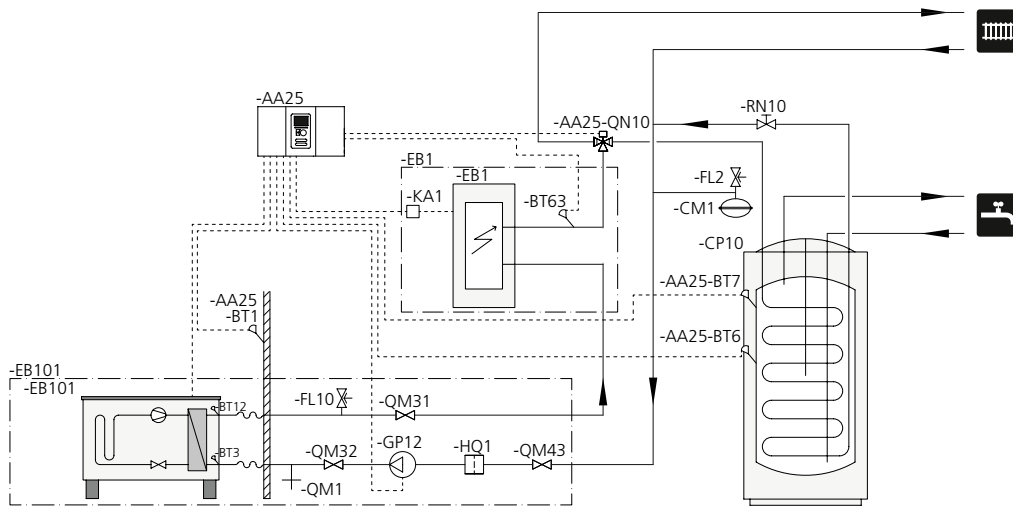

This installation alternative is suitable for simpler installations with a focus on low installation costs. SMO 20 (AA25) starts and stops the heat pump (EB101) to meet the heat and hot water demand of the installation. At simultaneous heating and hot water demand the reversing valve switches (AA25-QN10) periodically between the climate system and the water heater/accumulator tank (CP10).

When the water heater/accumulator tank (CP10) are fully charged the reversing valve (AA25-QN10) switches to the climate system. Additional heat (EB1) is connected automatically when the energy demand for the installation exceeds the heat pump capacity. This is used for both heating and charging hot water. The additional heat can also be used if a higher temperature of hot water is required than the heat pump can produce.

# GOOD TO KNOW ABOUT NIBE™ SMO 20

**System diagram for a compatible air/water heat pump together with SMO 20 and electric heater after reversing valve for hot water (floating condensing)**

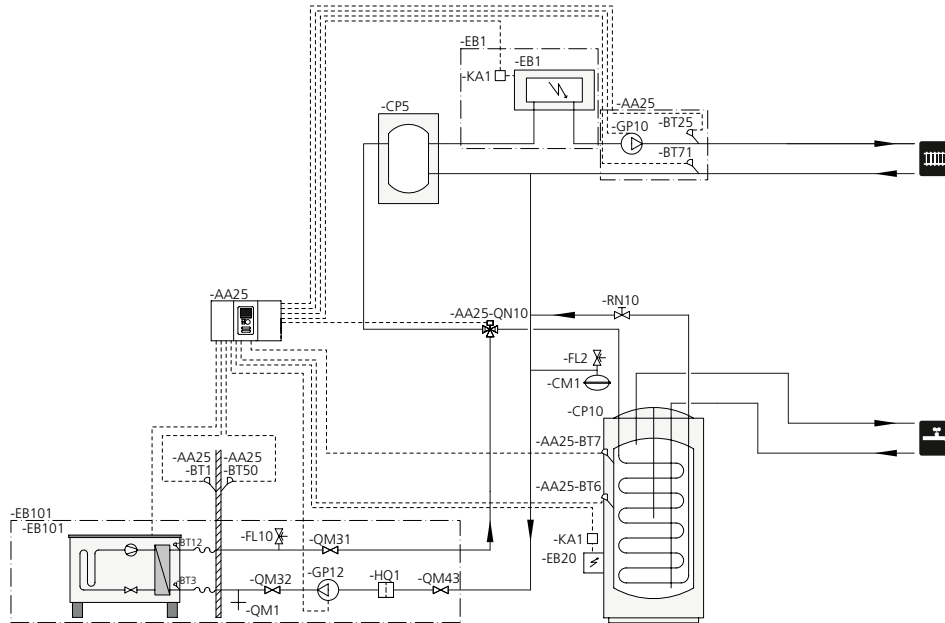

This installation alternative is suitable for more complex installations with a focus on comfort. SMO 20 (AA25) starts and stops the heat pump (EB101) to meet the heat and hot water demand of the installation. At simultaneous heat and hot water demand the reversing valve switches (AA25-QN10) periodically between the climate system and the water heater/accumulator tank (CP10). When the water heater/accumulator tank (CP10) are fully charged

the reversing valve (AA25-QN10) switches to the climate system. Additional heat (EB1) is connected automatically when the energy demand for the installation exceeds the heat pump capacity. Immersion heater (EB20) in the water heater/accumulator tank (CP10) is used during the time to produce hot water if the heat pump (EB101) is used for heating the building at the same time. The additional heat can also be used if a higher temperature of hot water is required than the heat pump can produce.

## List of components, AA25 SMO 20 system diagram

- BT1 Outdoor sensor
- BT6 Temperature sensor, hot water charging
- BT7 Temperature sensor, hot water top
- BT25 Temperature sensor, external supply
- BT50 Room sensor
- BT63 Temperature sensor, external supply line after electric heater
- BT71 Temperature sensor, external return line
- GP10 Circulation pump, Heating medium
- QN10 Reversing valve, Hot water/Heating medium
- EB1 Additional heat**
- EB1 Immersion heater
- KA1 Auxiliary relay/Contactor

## EB101 Heat pump system

- BT3 Temperature sensor, return line
- BT12 Temperature sensor, condenser supply line
- EB101 Heat pump
- FL10 Safety valve
- GP12 Charge pump
- HQ1 Particle filter
- QM1 Drain valve, Heating medium
- QM31 Shut-off valve, Heating medium, Supply
- QM32 Shut off valve, Heating medium, Return
- QM43 Shut-off valve

## Other information

- CM1 Expansion vessel closed, Hot water
- CP5 Buffer vessel (UKV)
- CP10 Accumulator tank with hot water heating
- EB20 Immersion heater
- FL2 Safety valve, Heating medium
- KA1 Auxiliary relay/Contactor
- RN10 Control valve

# GOOD TO KNOW ABOUT NIBE™ SMO 20

## Equipment SMO 20

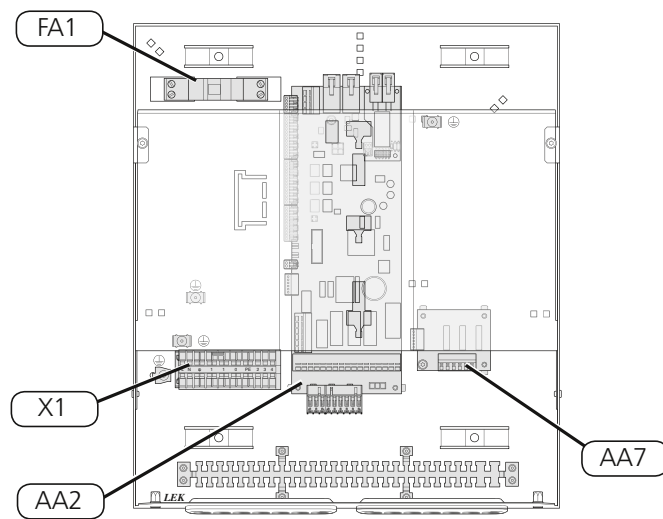
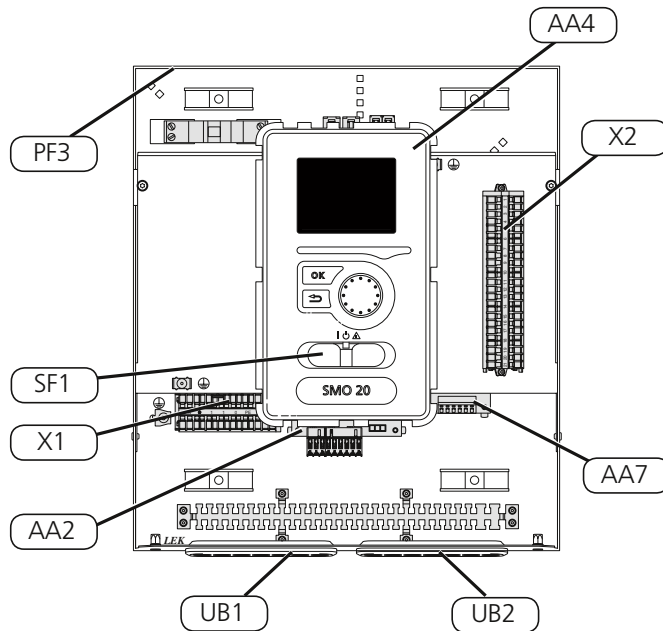

## GOOD TO KNOW ABOUT NIBE™ SMO 20

### List of components

#### Electrical components

AA 2	Base card
AA 4	Display unit
AA 7	Extra relay circuit board
FA 1	Miniature circuit-breaker
X 1	Terminal block, incoming electrical supply
X 2	Terminal block, control signal circulation pump, sensors AUX inputs and heat pump
SF 1	Switch
PF 3	Serial number plate
UB 1	Cable grommet, incoming supply electricity, power for accessories
UB 2	Cable gland, signal

Designations in component locations according to standard IEC 81346-1 and 81346-2.



# GOOD TO KNOW ABOUT NIBE™ SMO 20

## Dimensions SMO 20

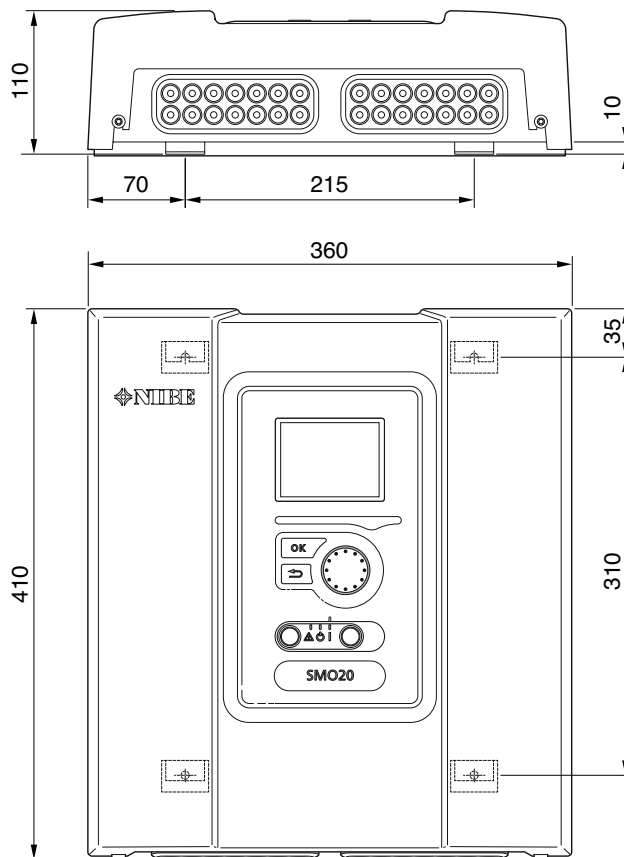

## Supplied components

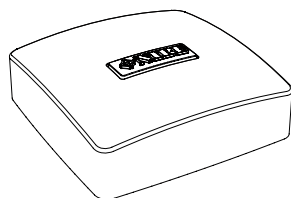

Outdoor sensor

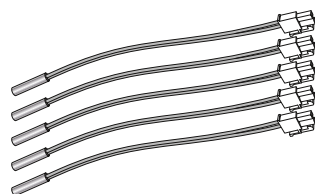

Temperature sensor



Heating pipe paste

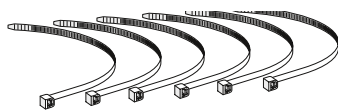

Cable tie

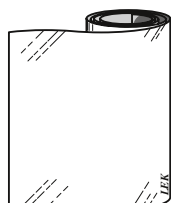

Aluminium tape

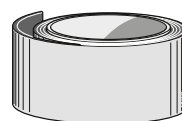

Insulation tape

## SYSTEM SOLUTIONS

The following combinations of products are recommended for control with SMO 20.

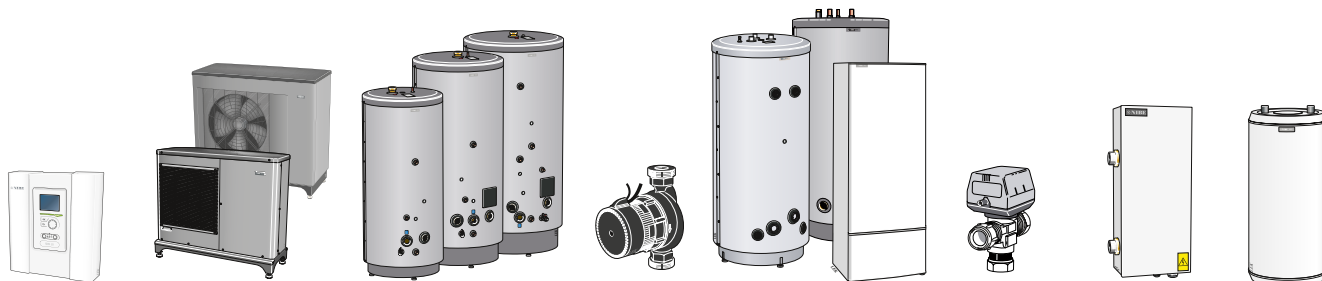

Control module	Air/water heat pump	Accumulator with hot water heater	Circ. pump	Water heater	HW Control	Addition	Volume vessel
SMO 20	F2030 – 7 kW	VPA 300/200 VPA 450/300 VPAS 300/450	CPD 10-25/55 CPD 10-25/60	VPB 200 VPB 300 VPBS 300 VPB 500 VPB 750-2 VPB 1000	VST 11	ELK 15 ELK 26	UKV 100 UKV 200 UKV 300 UKV 500
	F2030 – 9 kW						
	F2040 – 8 kW						
	F2040 – 12 kW						
	F2040 – 16 kW			VPB 500 VPB 750-2 VPB 1000	VST 20		
	F2300 – 14 kW						
	F2300 – 20 kW						



# INSTALLATION

## Control, general

The indoor temperature depends on several factors. Sunlight and heat emissions from people and household machines are normally sufficient to keep the house warm during the warmer parts of the year. When it gets colder outside, the climate system must be started. The colder it is outside, the warmer radiators and floor heating system must be.

Control of the heat production is performed based on the "floating condensing" principle, i.e. the temperature level needed for heating at a specific outdoor temperature is produced guided by collected values from the outdoor and supply temperature sensors. The room temperature sensor can also be used to compensate the deviation in room temperature.

## Control and scheduling heat production

The heat supply to the building is controlled in accordance with the selected control curve (curve slope and offset) in menu 1.9.1. After adjustment, the correct amount of heat for the current outdoor temperature is supplied. The supply temperature of the heat pump will hunt around the theoretically required value. For subnormal temperatures the control system calculates a heating deficit in the form of "degree-minutes", which means that heating production is accelerated. The larger the subnormal temperature, the greater the heat production.

## Hot water production

When there is a demand for hot water, the heat pump gives this priority and devotes its entire output to water heating. No room heat is produced in this mode. Maximum time for hot water charging can be adjusted in the menu system. After this, heating is produced for the remaining period of time before further water heating can take place.

Hot water charging starts when the hot water sensor has fallen to the set start temperature. Hot water charging stops when the hot water temperature on the hot water sensor (BT6) has been reached. For occasional higher demand for hot water, the "temporary lux" can be used to raise the temperature for 3 – 12 hours (selected in the menu system).

## Alarm indications

The status lamp lights red in the event of an alarm and the display shows detailed information depending on the fault. An alarm log is created with each alarm containing a number of temperatures, times and the status of outputs.

## Own curve

F1255 has pre-programmed non linear heating curves. It is also possible to create an own defined curve. This is an individual linear curve with one break point. You select a break point and the associated temperatures.

## Room sensor

A room temperature sensor can be connected to SMO 20. The room temperature sensor has up to three functions:

1. Show current room temperature in the control module display.
2. Option of changing the room temperature in °C.
3. Makes it possible to change/stabilise the room temperature.

The control module operates without the sensor, but the sensor must be installed if one wishes to readout the accommodation's indoor temperature in SMO 20's display. The sensor must be activated in menu 1.9.4 if the sensor is to be used to change the room temperature in °C and/or to change/stabilise the room temperature.

## Relay output for emergency mode

The emergency mode relay can be used to activate external additional heat, an external thermostat must then be connected to the control circuit to control the temperature. Ensure that the heating medium circulates through the external additional heating. No hot water is produced when emergency mode is activated.

## External circulation pump

Heat production is controlled by the outdoor temperature and a theoretical desired value of the indoor temperature. This occurs in accordance with a chosen setting of the regulating curve (curve slope and offset) in menu 1.9.1.

To reach a high level of heating comfort during the heating phase, the external circulation pump circulates the hot water in the heating system even when the domestic hot water output is high.



# INSTALLATION

## USB service outlet

SMO 20 is equipped with a USB socket in the display unit. This USB socket can be used to connect a USB memory to update the software, save logged information and handle the settings in SMO 20.

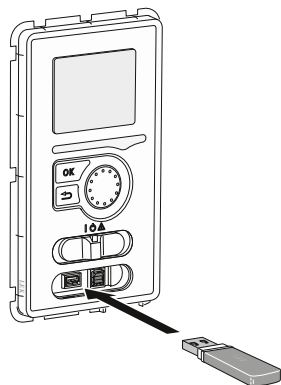

## Compatible NIBE air/water heat pumps

Compatible NIBE air/water heat pumps must be equipped with a control card that has at least the software version given in the following list. The control card version is displayed in the heat pump's display (if applicable) upon start-up.

Product	Program version
F2025	55
F2026	55
F2030	All versions
F2040	All versions
F2300	55

## External connection options

SMO 20 has software controlled inputs and outputs for connection of sensors and external switch function. This means that a sensor or an external switch function can be connected to one of six special connections where the function for connection is decided in the control module software.

If an external switch function is connected to SMO 20 the function for used input or output must be selected in menu 5.4.

## Possible selection for AUX inputs

Following functions can be connected to the AUX inputs. Some of the functions can also be activated and scheduled via menu settings.

- Temperature sensor, external return line
- Switch for external blocking of addition
- Contact for external blocking of compressor in the heat pump
- Contact for external tariff blocking
- Switch for external blocking of heating
- Contact for activation of "temporary lux"
- Contact for activation of "external adjustment"

## Possible selection for AUX outputs

It is possible to have an external connection through the relay function via a potential free variable relay (max 2 A) on the terminal block X4 on the base card (AA2).

Optional functions for external connection:

- Indication of buzzer alarm.
- Control of circulation pump for hot water circulation.

If any of the above is installed to terminal block X4 on the base card the function must be selected in menu 5.4. The common alarm is preselected at the factory.



## THE DISPLAY

A large, easy to read multicolour display gives everyone the chance to maximize the energy saving potential of this exciting green technology!

### Display unit

#### Display, A

Instructions, settings and operational information are shown on the display. The easy-to-read display and menu system, facilitates navigation between the different menus and options to set the comfort or obtain the information you require.

#### Status lamp, B

The status lamp indicates the status of the heat pump. It:

- lights green during normal operation.
- lights yellow in emergency mode.
- lights red in the event of a deployed alarm.

#### OK button, C

The OK button is used to:

- confirm selections of sub menus/options/set values/page in the start guide.

#### Back button, D

The back button is used to:

- go back to the previous menu.
- change a setting that has not been confirmed.

#### Control knob, E

The control knob can be turned to the right or left. You can:

- scroll in menus and between options.
- increase and decrease the values.
- change page in multiple page instructions (for example help text and service info).

#### Switch, F

The switch assumes three positions:

- On (I)
- Standby (⏻)
- Emergency mode (⚠)

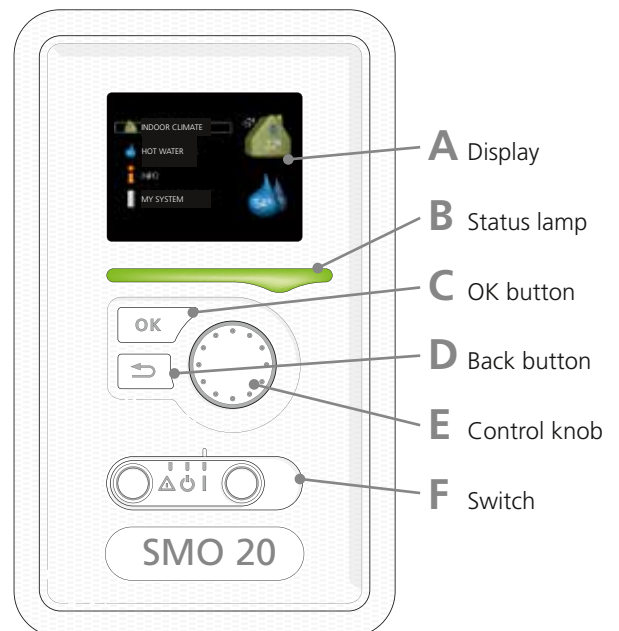

## THE DISPLAY

### Menu system

When the door to the heat pump is opened, the menu system's four main menus are shown in the display as well as certain basic information.

#### Menu 1 – Indoor climate

Setting and scheduling the indoor climate.

#### Menu 2 – Hot water

Setting and scheduling hot water production.

This menu only appears if a water heater is docked to the heat pump.

#### Menu 3 - Info

Display of temperature and other operating information and access to the alarm log.

#### Menu 4 – My system

Setting time, date, language, display, operating mode etc.

#### Menu 5 - Service

Advanced settings. These settings are not available to the user. The menu is visible by pressing the Back button for 7 seconds.

### Start guide

The first time the heat pump is started a start guide is started. The start guide instructions state what needs to be carried out at the first start together with a run through of the heat pump's basic settings.

The start guide ensures that the start-up is carried out correctly and cannot be bypassed. The start guide can be started later in menu 5.7.

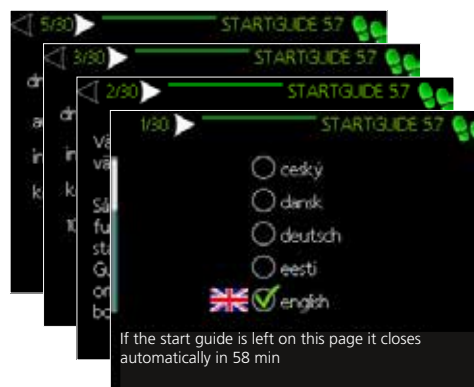
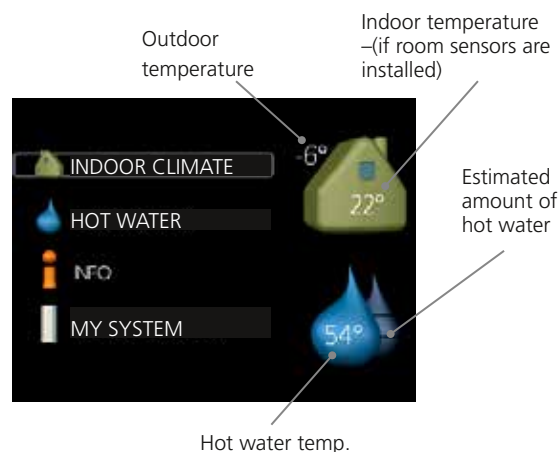

## TECHNICAL SPECIFICATIONS



<b>SMO 20</b>		
Width	(mm)	360
Height	(mm)	410
Depth	(mm)	110
Weight, (without packaging and enclosed components)	(kg)	4,3
Enclosure class		IP21
Max number air/water heat pumps		1
Max number of sensors		7
Max number of charge pumps		1
Max number of circulation pumps/climate systems		1
Mains voltage		230 V 2~ 50 Hz
Max. current	(A)	2
Max number of additional steps		3
Operation mode (EN60730)		Type 1
Electrical contamination		2
Area of operation	(°C)	-25 – 70
Ambient temperature	(°C)	5 – 35
Program cycles		Hours: 1, 24 Days: 1, 2, 5, 7
Resolution, program	(min)	1
Rated value for impulse voltage	(kV)	4

## ACCESSORIES

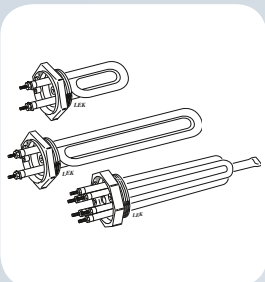

### Immersion heater IU

3 kW  
6 kW  
9 kW

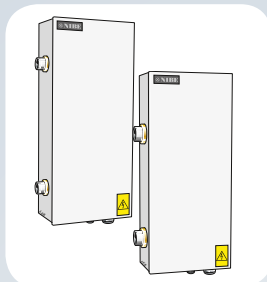

### External electrical addition

#### ELK

#### ELK 15

Immersion heater  
15 kW, 3 x 400 V

#### ELK 26

Immersion heater  
26 kW, 3 x 400 V



### Auxiliary relay HR 10

Auxiliary relay for control of  
external 1 to 3 phase loads.

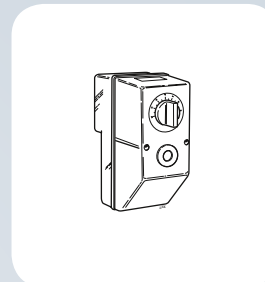

### Junction box K11

Junction box with thermostat  
and overheating protection.

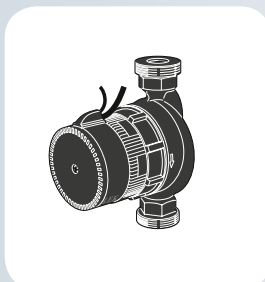

### Charge pump CPD 10

Charge pump for heat pump

CPD 10-25/55  
CPD 10-25/60



### Rumsgivare RTS 40

Room sensor used to obtain a  
more even indoor temperature.

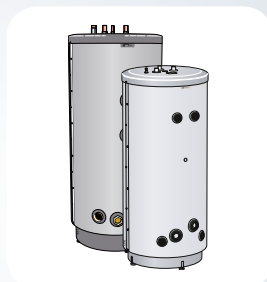

### VPA

Double-jacketed hot water cylinder

VPA 300/200  
VPA 450/300  
VPAS 300/450

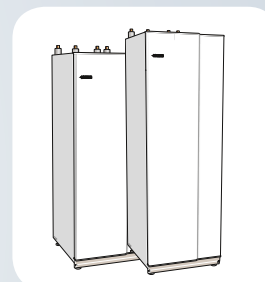

### VPB 200 VPB 300

Water heater with charge coil



### VPB

Water heater with charge coil

VPB 500  
VPB 750-2  
VPB 1000

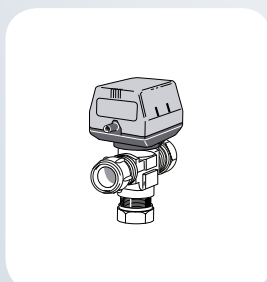

### Hot water control VST11

Reversing valve, Ø 28 mm, com-  
pression ring  
Max recommended charge  
power, 17 kW

### VST20

Reversing valve, Ø 35 mm, com-  
pression ring  
Max recommended charge  
power, 40 kW

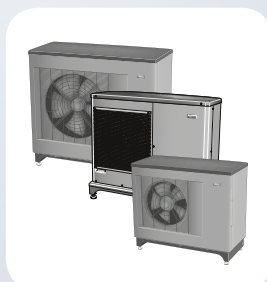

### Heat pump

#### F2030

7 kW / 9 kW

#### F2040

8 kW / 12 kW / 16 kW

#### F2300

14 kW / 20 kW



NIBE is ISO-certified:  
SS-EN ISO 9001:2000  
SS-EN ISO 14001:2004

This brochure is a publication from NIBE. All product illustrations, facts and specifications are based on current information at the time of the publication's approval. NIBE makes reservations for any factual or printing errors in this brochure.  
Photos: [www.benfoto.se](http://www.benfoto.se). ©NIBE 2013.



NIBE Energy Systems AB  
Box 14  
285 21 Markaryd  
SWEDEN  
Tel. +46 433 - 73 000  
[www.nibe.eu](http://www.nibe.eu)