



A SMALL DETAIL WITH GREAT POWER.

NIBE F470 is a complete exhaust air heat pump for new installations and replacement in houses and other properties.

- Display unit with easy-to-read colour screen
- Low energy fans
- Great savings thanks to large compressor with intelligent control to work with the most favourable temperature conditions.
- Outdoor temperature sensor/Room temperature sensor
- Schedule heating, ventilation and hot water, plus holiday mode
- Uses environmentally-friendly R290 (Propane) refrigerant
- Controls up to four heating systems, with different temperature levels
- Phase individual load monitor
- Communicates with mobile phone using GSM (accessory)
- Smart ventilation design for low noise level and high ventilation capacity
- Measures and logs average indoor temperature during the heating season

NIBE F470 can be used in low energy/passive houses requiring exhaust and supply ventilation in combination with energy efficient water heating. It allows waterborne comfort heating in areas such as toilets and bathrooms.

- Energy efficient ventilation through low energy fans
- Offers higher energy savings compared to the FTX unit as heat recovery can be used for hot water and comfort heating all year round
- Room temperature sensor that stabilises room temperature depending on body heat, solar radiation etc.
- Complete, compact, high value system with ventilation, hot water and heating all in the same product

NIBE F470

NIBE F470 is an exhaust air heat pump with supply air coil. It has integrated DC fans and water heater with copper or stainless steel corrosion protection. It comes with an integrated immersion heater.

NIBE F470 reduces energy costs considerably by recovering energy from ventilation air and supplying it to the heat pump. The device ventilates homes, supplies heat and produces domestic hot water. It is intended for low temperature dimensioned radiator circuits and/or under floor heating. NIBE F470 can be docked to other heat sources such as district heating.

HOW DO EXHAUST AIR HEAT PUMPS WORK?

Ventilation, which means totally hygienic inside air, is a basic requirement for living in a healthy house. Controlled domestic ventilation with heat recovery reuses energy from exhaust air.

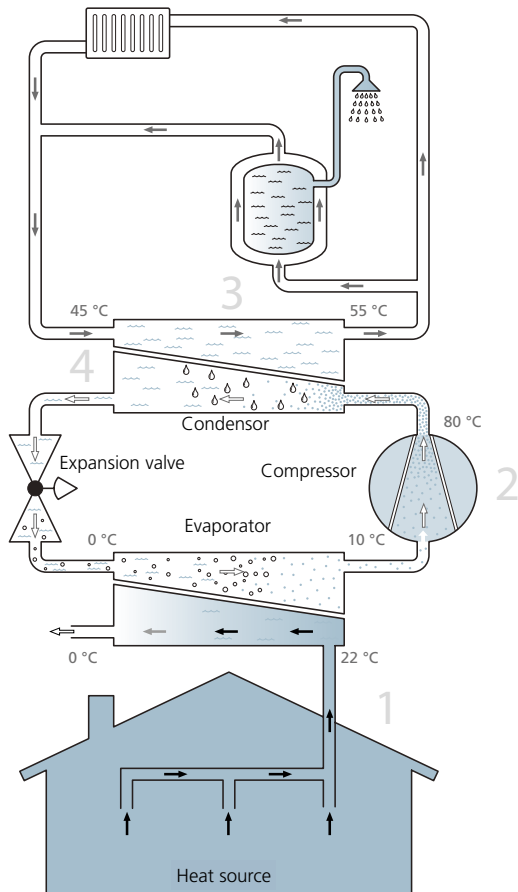

1. Warm exhaust air is blown across the heat exchange and heat is transferred into the refrigerant circuit. Cold exhaust air passes to the outside of the house.
2. The compressor raises the pressure of the refrigerant, resulting in an increase in temperature in the heat pump.
3. Energy extracted from exhaust air is transferred into a water-based heating system to heat your home and hot water.
4. Refrigerant reverts to liquid form in the condenser, ready to turn into gas once more and collect new heat energy.

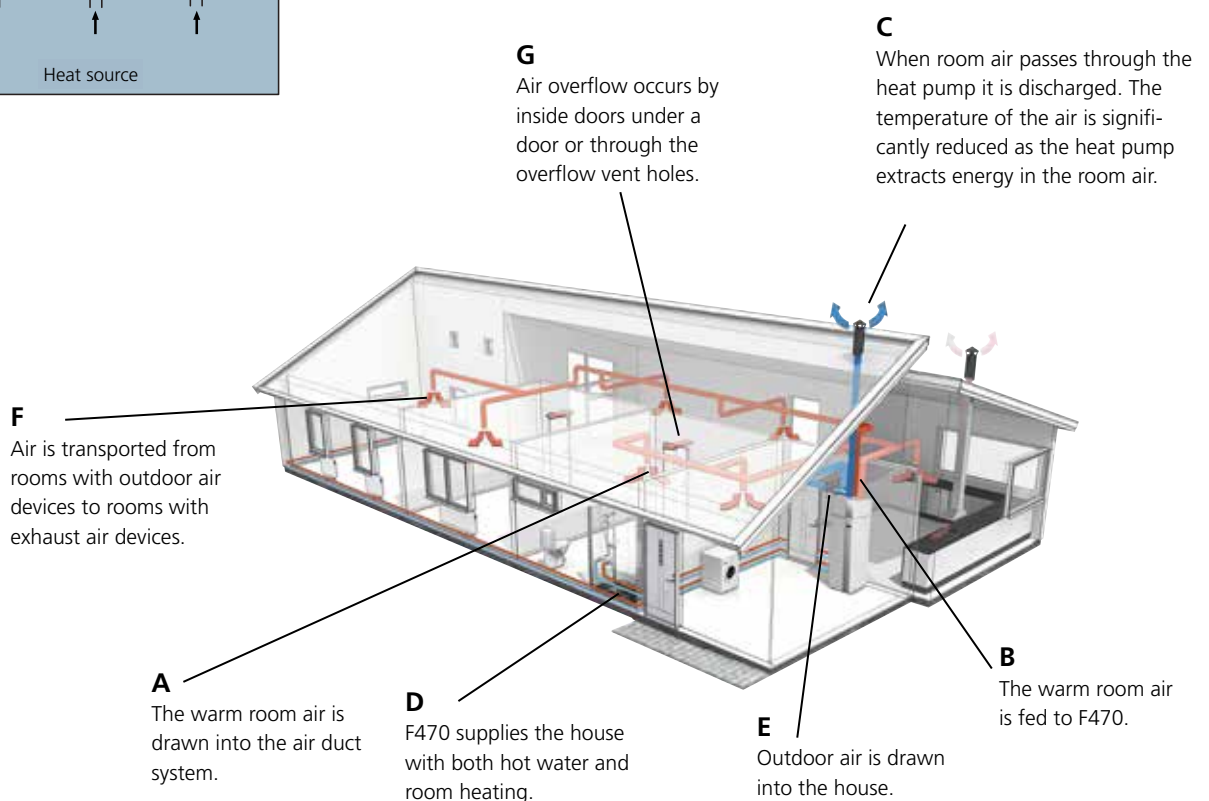

GOOD TO KNOW ABOUT NIBE™ F470

Maintenance

The control panel is designed to offer the simplest possible operation. It requires minimum maintenance. All that needs doing is checking safety valves and cleaning air filters and fans. The air filters are located in filter cartridges and are very easy to clean.

Equipment

NIBE F470 is equipped with a complete set of valves, consisting of a drain valve, filling valve, vacuum valve, non-return valve, and safety valve for the water heater section. The boiler section is equipped with a drain valve, filler valve and safety valve. In addition, the unit is equipped with climate controlled heating automatic devices with outdoor temperature, room temperature and flow sensors, circulation pump, load monitor and expansion vessel.

Transport and storage

NIBE F470 should be transported and stored vertically and stored in a dry place. F470 may be carefully laid on its back when being moved. The centre of gravity is in the upper part of the pump.

Design

A microprocessor controls NIBE F470 for easy operation and to make sure the heat pump runs as efficiently as possible by choosing the best method of operation. The microprocessor also manages the heating automatic device and circulation pump. It can also control an automatic bypass when two different flow temperatures are needed. The display shows current temperatures and set values in plain text.

The design of the ventilation section ensures a high ventilation capacity. The reconnectable fan steps can easily be increased or decreased via the internal clock, control panel or an external signal.

Insulation consists of moulded Neopor (environmentally friendly cellular plastic) for minimal heat loss.

The outer casing is made of white powder-coated steel plate. The front door is easy to remove for easy access when installing and for servicing.

NIBE F470 has a maximum immersion heater output of 10.25 kW, which is easy to adjust via the display. It can be blocked if necessary.

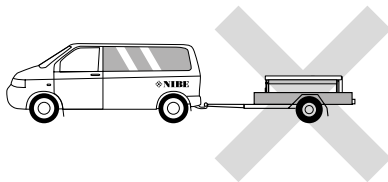

GOOD TO KNOW ABOUT NIBE™ F470

Equipment

F470

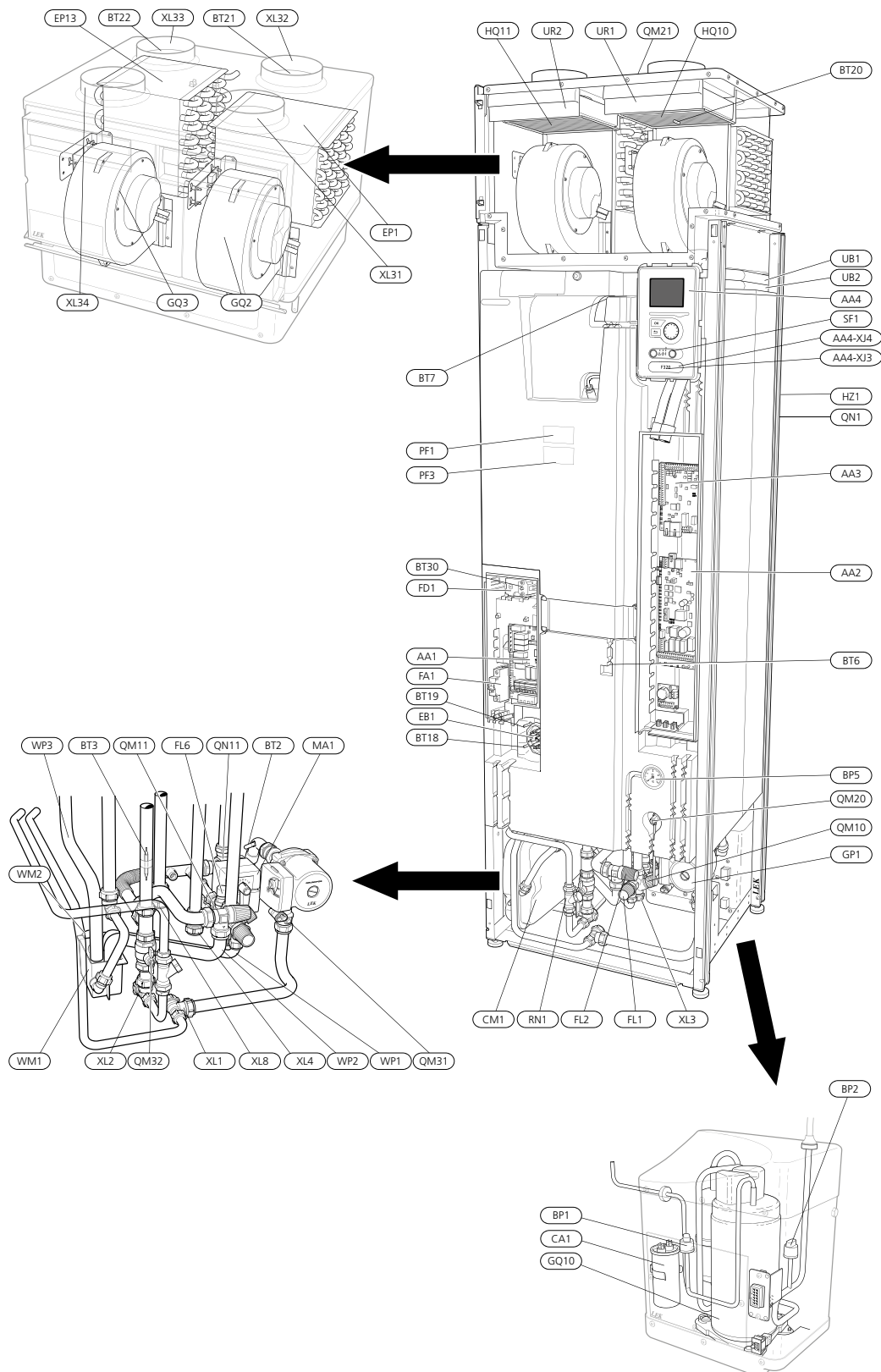

GOOD TO KNOW ABOUT NIBE™ F470

List of components

Pipe connections

XL1	Connection, heating medium flow line
XL2	Connection, heating medium return line
XL3	Connection, cold water
XL4	Connection, hot water
XL8	Connection, docking in
XL31	Ventilation connection, exhaust air
XL32	Ventilation connection, extract air
XL33	Ventilation connection, supply air
XL34	Ventilation connection, outdoor air

HVAC components

CM1	Expansion vessel
EP13	Supply air battery
FL1	Safety valve, hot water heater
FL2	Safety valve, climate system
FL6	Vacuum valve
GP1	Circulation pump
QM10	Filler valve, hot water heater
QM11	Filler valve, climate system
QM20	Venting, climate system
QM21	Venting, supply air coil
QM31	Shut-off valve, heating medium flow
QM32	Shut off valve, heating medium return
QN11	Mixing valve
RN1	Trim valve
WM1	Drip tray
WM2	Overflow water discharge
WP1	Overflow pipe, safety valve hot water heater
WP2	Overflow pipe, safety valve climate system
WP3	Condensation lead off, fan box

Sensors etc.

BP1	High pressure pressostat
BP2	Low pressure pressostat
BP5	Pressure gauge, heating system
BT2	Temperature sensors, heating medium flow
BT3	Temperature sensors, heating medium return
BT6	Temperature sensor, hot water, control
BT7	Temperature sensor, hot water, display
BT18	Temperature sensor, compressor operation
BT19	Temperature sensor, immersion heater operation
BT20	Temperature sensor, exhaust air
BT21	Temperature sensor, extract air
BT22	Temperature sensor, supply air
BT30	Thermostat, backup heating

Electrical components

AA1	Immersion heater card
AA2	Base card
AA3	Input circuit board
AA4	Display unit
	AA4-XJ3 USB port
	AA4-XJ4 Service socket
CA1	Capacitor
EB1	Immersion heater
FA1	Miniature circuit-breaker
FD1	Temperature limiter
MA1	Shunt motor with handwheel
SF1	Switch

Cooling components

EP1	Evaporator
GQ10	Compressor
HZ1	Drying filter with tank
QN1	Expansion valve

Ventilation

GQ2	Exhaust air fan
GQ3	Supply air fan
HQ10	Exhaust air filter
HQ11	Supply air filter
UR1	Filter cover, exhaust air
UR2	Filter cover, supply air

Other information

PF1	Rating plate
PF3	Serial number plate
UB1	Cable grommet
UB2	Cable grommet

Designations in component locations according to standard IEC 81346-1 and 81346-2.

GOOD TO KNOW ABOUT NIBE™ F470

Dimensions

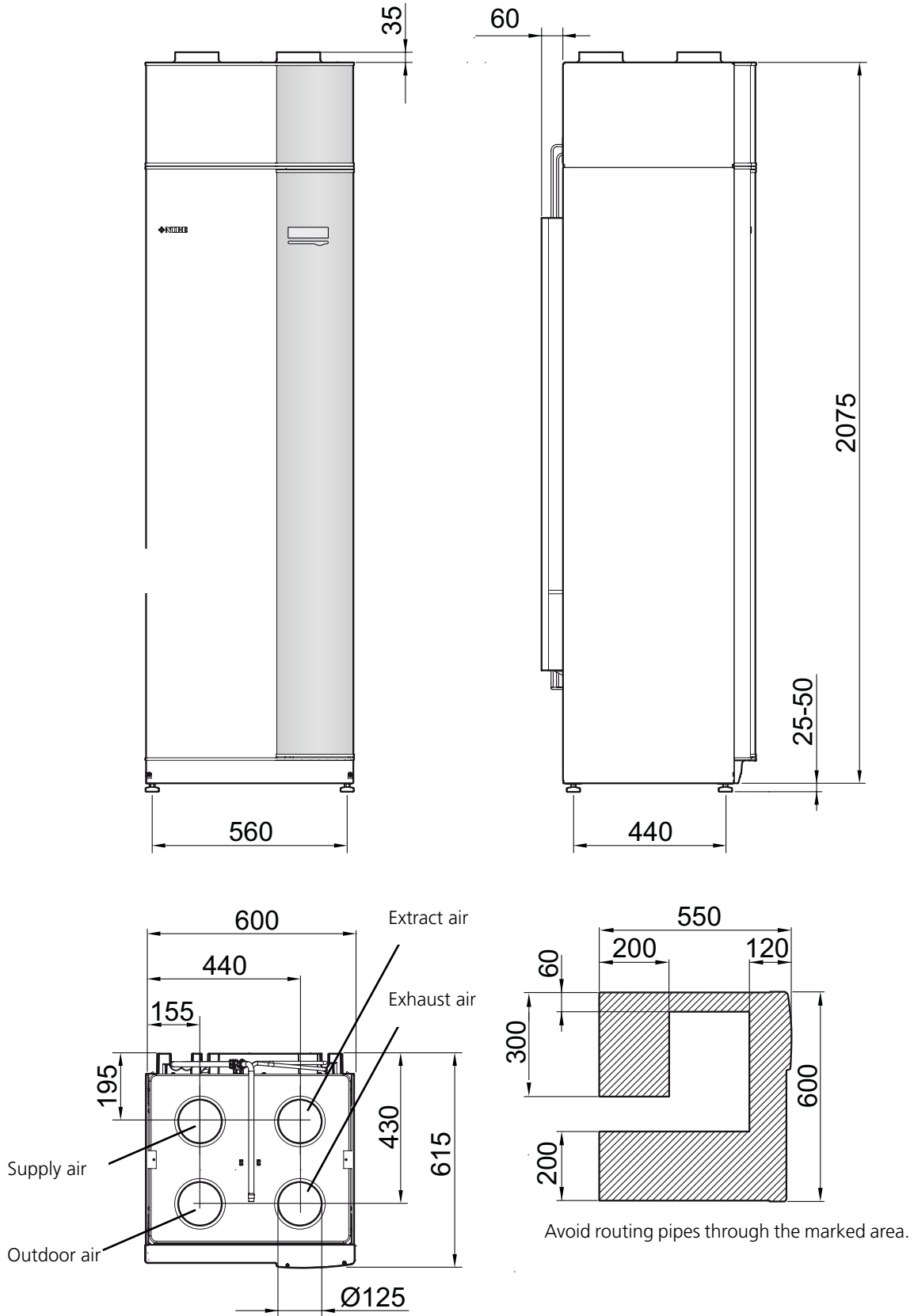

INSTALLATION

Pipe connections

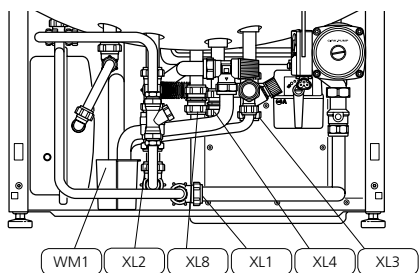
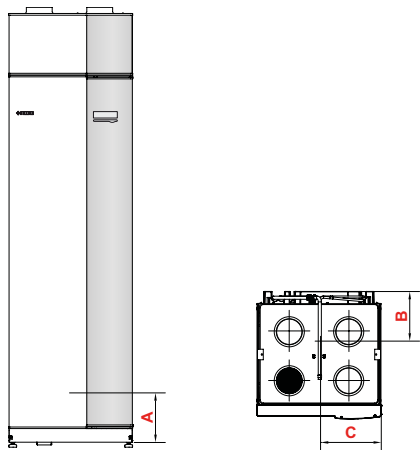

Setting out dimensions

Connection		A	B	C
XL 1 Heating medium flow	(mm)	30	465	320
XL 2 Heating medium return	(mm)	45	420	365
XL 3 Cold water	(mm)	165	455	210
XL 4 Hot water	(mm)	170	400	260
XL 8 Docking	(mm)	175	290	295
WM 1 Overflow cup	(mm)	60	200	420

Pipe dimensions

Connection		
Heating medium ext Ø	(mm)	22
Cold water ext Ø	(mm)	22
Hot water ext Ø	(mm)	22
Docking ext Ø	(mm)	22
Overflow water discharge	(mm)	32

Installation and positioning

To facilitate pipe installation, a space should be left for the distribution manifold etc on the right or left-hand side. For other installation dimensions, see "Dimensions".

Install the heat pump with its back to an outside wall, in a room where noise does not matter, in order to eliminate noise problems. If this is not possible, avoid using a wall that backs on to a bedroom or some other room where noise would be a problem. Leave space between the heat pump and wall behind (and any routing of supply cables and pipes) to reduce the risk reproduction of any vibration. Route pipes so they are not fixed to an internal wall that backs on to a bedroom or living room.

The heat pump installation area should always have a temperature of at least 10 °C and max 30 °C.

Installation area

Leave a space of 500 mm in front of the heat pump. Approximately 50 mm free space is required on each side in order to open the side hatches. The hatches do not need to be opened during service, all service on F470 can be carried out from the front.

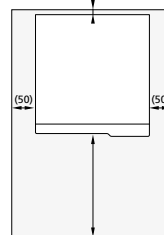

Pipe installation

Pipe installation must be carried out in accordance with current norms and directives.

All pipe connections are equipped with 22 mm compression ring couplings.

Radiator connection

When the circulation pump is operating, the flow in the heating system must not be stopped completely, i.e. at least one of the heating system's radiators/under floor heating loops must be fully open.

Tap water connection

If a bubble pool or other significant consumer of hot water is installed the heat pump should be supplemented with an external water heater, such as NIBE COMPACT.

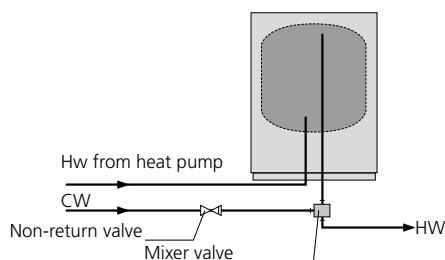

INSTALLATION

Electrical connections

Connection must not be carried out without the permission of the electricity supplier and must be under the supervision of a qualified electrician.

NIBE F470 must be connected with the corresponding connection cable (length 2 m) via an isolator switch with a minimum breaking gap of 3 mm. Minimum cable area must be dimensioned according to the fuse rating used. The connection cable can be found on the reverse of F470 (see image below).

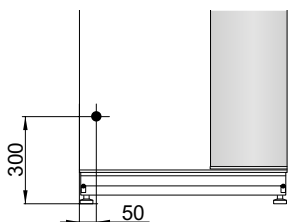

The requisite circuit fuse is based on the table below.

Other electrical equipment is connected at the factory, except the outdoor and room temperature sensors. Also see the section "External control and load monitor". Operation (230V), fan and circulation pump are internally fused by a miniature circuit breaker (10A).

Electrical addition (kW)	Max (A) L1	Max (A) L2	Max (A) L3
0	6.3	-	-
0.25	6.3	1.1	-
2	6.3	-	8.7
4.67	6.3	11.6	8.7
5.60	6.3	12.7	11.6
8	17.9	11.6	11.6
10.25	17.9	12.7	20.3

The table displays the maximum phase current for the relevant electrical step for the heat pump.

Inspection

NIBE F470 is equipped with a closed expansion vessel as standard. Current norms require the heating installation to be inspected before it is commissioned. This inspection should only be made by persons with the necessary expertise.

Function checks of the ventilation system must only be carried out by authorised persons or in accordance with the applicable regulation.

Maximum boiler and radiator volumes

The volume of the expansion vessel is 10 litres and it is pressurised as standard to 0.5 bar (5 mvp). As a result, the maximum height between the vessel and the highest radiator is 5 metres. There is a valve on the vessel for any pre-pressure adjustment.

The initial pressure of the expansion vessel must be stated in the inspection document.

The maximum system volume excluding the boiler is 219 litres at the above initial pressure.

Pump and pressure drop diagram

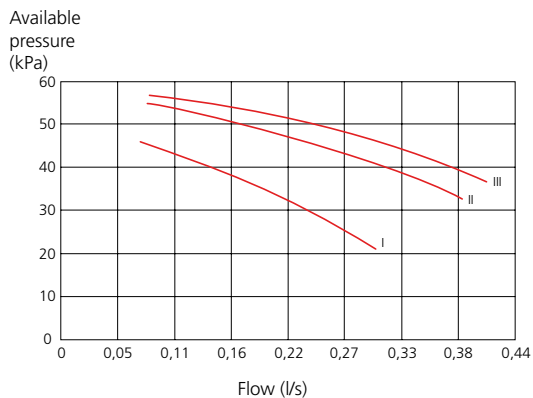

Outdoor and room temperature sensors

Connect the sensors with two-core cable to terminal block. The minimum cable cross section should be 0.4 mm² up to lengths of 50 metres, for example, EKKX or LiYY.

Install the outdoor temperature sensor in the shade on a wall facing north or north-west, so it is unaffected by the morning sun. If a conduit is used it must be sealed to prevent condensation in the sensor capsule.

Install the room temperature sensor in a neutral position where the shown temperature is required.

External control and load monitor

In cases where an external control is required, it can be connected to a terminal block.

NIBE F470 is internally equipped with a load monitor. If it is used, the supplied current sensors must be installed in the electrical distribution unit and connected to a terminal block in the heat pump.

If the current sensors are connected, the heat pump monitors the phase currents and allocates the electrical steps automatically to the least loaded phase.

The control system must be set for the installation's main fuse so that the load monitor can work correctly.

INSTALLATION

Ventilation

Connect NIBE F470 so that all ventilation air except air from the kitchen fan passes the evaporator in the heat pump. Normed min flow is 0.35 l/s per m² living area. For optimum heat pump performance ventilation flow should not be less than 28 l/s (100 m³/h) at an exhaust air temperature of at least 20 °C. On occasions when the exhaust air temperatures are lower than 20 °C (for example on start up and when there is no one at home) the minimum value is 31 l/s (110 m³/h). Even if the norm requirements give lower flow requirements, increasing to 110 m³ /does not mean an increase in energy consumption as the recovery level of the heat pump also increases.

Reconnection of the ventilation capacity occurs steplessly.

Connections must be made via flexible hoses, which must be installed so that they are easy to replace. The extract air and outdoor air ducts are to be insulated using diffusion-proof material (PE30) along their entire lengths. Exhaust air ducts that are laid in cold areas must be insulated. Provision must be made for inspection and cleaning of the duct. Make sure that there are no reductions of cross-sectional area in the form of creases, tight bends etc, since this will reduce the ventilation capacity. All joins in the ducting must be sealed and pop-riveted to prevent leakage. The duct system must be installed in accordance with current norms. A minimum of air tightness class B is recommended. The exhaust air duct must be a maximum of 20 m long with a maximum of six bends.

To prevent fan noise being transferred to the air devices, install silencers in the ducts. This is also recommended for shorter extract air ducts.

To obtain the necessary air exchange in every room of the house, the exhaust and supply air devices must be correctly positioned and adjusted. A defective ventilation installation may lead to reduced installation efficiency and thus poorer operating economy, and may result in moisture damage to the house.

The extract air duct must not be routed to the flue.

If a stove or similar is installed, it must have sealing doors and be able to take combustion air from outside.

Setting the fan capacity

Select the ventilation capacity in the display.

Fan diagram

The diagram below shows the available ventilation capacity. Min exhaust air flow is 28 l/s (100 m³/h) at exhaust air temperatures of 20 °C or higher.

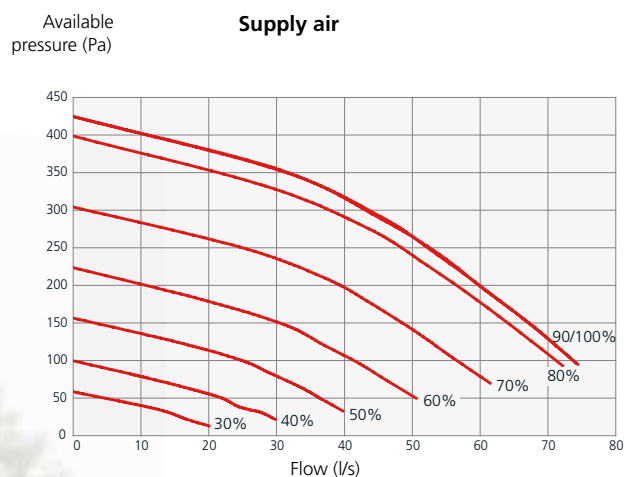
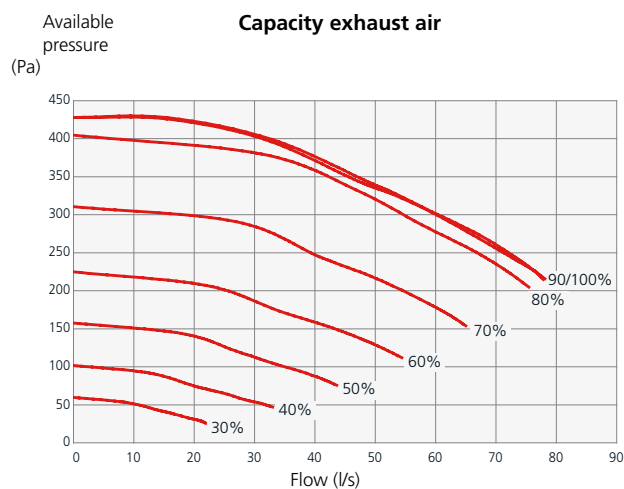

INSTALLATION

Control, general

The indoor temperature depends on several factors. Sunlight and heat emissions from people and household machines are normally sufficient to keep the house warm during the warmer parts of the year. When it gets colder outside, the climate system must be started. The colder it is outside, the warmer radiators and floor heating system must be.

Control of the heat production is performed based on the floating condensing principle, i.e. the temperature level needed for heating at a specific outdoor temperature is produced guided by the collected values from the outdoor and flow sensors. The room sensor can also be used to compensate the deviation in room temperature.

Heat production

The heat supply to the building is controlled in accordance with the selected control curve (curve slope and offset) in menu 1.9.1. After adjustment, the correct amount of heat for the current outdoor temperature is supplied. The flow line temperature of the heat pump will hunt around the theoretically required value.

Hot water production

Hot water charging starts when the hot water sensor has fallen to the set start temperature. Hot water charging stops when the hot water temperature on the hot water sensor has been reached.

For occasional higher demand for hot water, temporary lux can be used to raise the temperature for 3 – 12 hours (selected in the menu system).

Additional heat only

F470 can be used with only additional heat (electric boiler) to produce heating and hot water, for example, before the ventilation system is complete.

Alarm indications

The status lamp lights red in the event of an alarm and the display shows detailed information depending on the fault. An alarm log is created with each alarm containing a number of temperatures, times and the status of outputs.

Own curve

F470 has pre-programmed non linear heating curves. It is also possible to create your own defined curve. This is an individual linear curve with one break point. You select a break point and the associated temperatures.

USB service outlet

F470 is equipped with a USB socket in the display unit. This USB socket can be used to connect a USB memory stick to update the software, save logged information and handle the settings in F470.

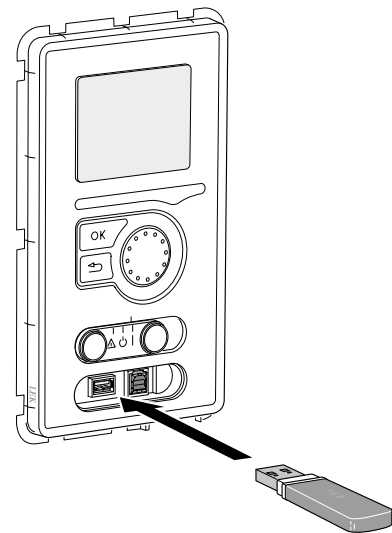

SMS 40

F470 can be controlled and monitored externally with accessory SMS 40.

SMS 40 consists of a communications module, a GSM modem with an antenna and a separate power supply unit with jack for plugging into a wall socket. The antenna can be placed outside the enclosure.

SMS 40 enables operation to be controlled and monitored via a GSM module, using a mobile phone via SMS messages. For the GSM function to work, the communications module must be equipped with a valid GSM subscription. This may be a cash card or a special telematics subscription.

Visit www.nibe.eu for more information.

THE DISPLAY

A large, easy to read multicolour display gives everyone the chance to maximize the energy saving potential of this exciting green technology!

Display unit

Display, A

Instructions, settings and operational information are shown on the display. The easy-to-read display and menu system facilitates navigation between the different menus and options to set the comfort or obtain the information you require.

Status lamp, B

The status lamp indicates the status of the heat pump. It:

- lights green during normal operation.
- lights yellow in emergency mode.
- lights red in the event of a deployed alarm.

OK button, C

The OK button is used to:

- confirm selections of sub menus/options/set values/page in the start guide.

Back button, D

The back button is used to:

- go back to the previous menu.
- change a setting that has not been confirmed.

Control knob, E

The control knob can be turned to the right or left. You can:

- scroll in menus and between options.
- increase and decrease the values.
- change page in multiple page instructions (for example help text and service info).

Switch, F

The switch assumes three positions:

- On (I)
- Standby (⏻)
- Emergency mode (⚠)

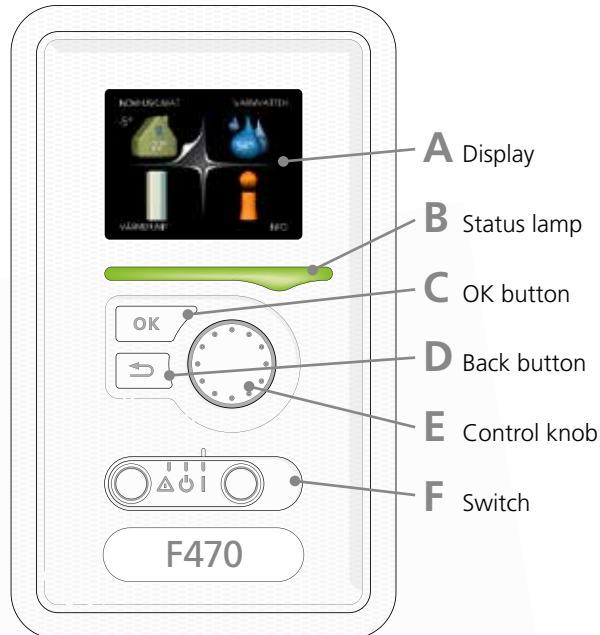

THE DISPLAY

Menu system

When the door to the heat pump is opened, the menu system's four main menus are shown in the display as well as certain basic information.

Menu 1 – Indoor climate

Setting and scheduling the indoor climate.

Menu 2 – Hot water

Setting and scheduling hot water production.

This menu only appears if a water heater is docked to the heat pump.

Menu 3 – Info

Display of temperature and other operating information and access to the alarm log.

Menu 4 – Heat pump

Setting time, date, language, display, operating mode etc.

Menu 5 – Service

Advanced settings. These settings are not available to the user. The menu is visible by pressing the Back button for 7 seconds.

Start guide

The first time the heat pump is switched on it initiates a start guide. The start guide instructions state what should be carried out at the first start, together with a run through of the heat pump's basic settings.

The start guide ensures that start-up is carried out correctly and cannot be bypassed. The start guide can be initiated later in menu 5.7.

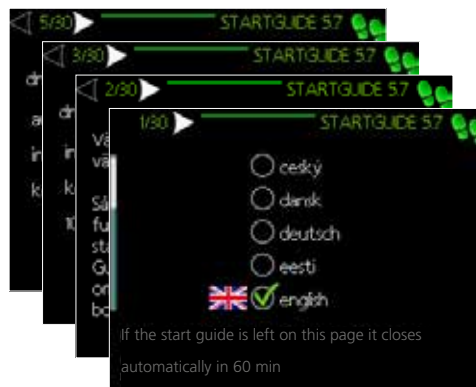
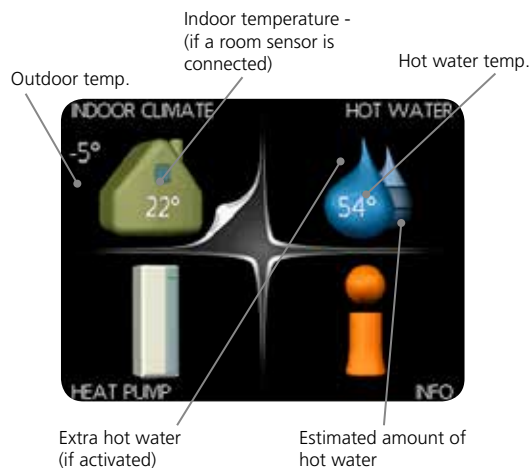

TECHNICAL SPECIFICATIONS



Output data according to EN 14,511		
Specified heating output (P_H) ¹	kW	2.18
COP ¹		3.93
Specified heating output (P_H) ²	kW	2.03
COP ²		3.24
Specified heating output (P_H) ³	kW	1.88
COP ³		2.74
Additional power		
Output immersion heater	kW	10.25
Electrical data		
Rated voltage	V	400 V 3N~PE 50 Hz
Driving power circulation pump	W	45-100
Driving power exhaust air respectively supply air fan	W	25-140
Enclosure class		IP21
Refrigerant circuit		
Type of refrigerant		R290, propane
Volume	kg	0.440
Heating medium circuit		
Max pressure in boiler section	MPa/bar	0.25/2.5
Ventilation		
Min air flow at exhaust air temperature at least 20 °C	l/s	28
Min air flow at exhaust air temperature below 20°C	l/s	31
Sound pressure level according to EN 12 102		
Sound pressure level in boiler room ($L_{p(A)}$) ⁴	dB(A)	47.5-50.5
Water heater and boiler section		
Volume boiler section	litre	70
Volume, hot water heater	litre	170
Max pressure in hot water heater	MPa/bar	1.0/10
Capacity water heating according to EN 255-3⁵		
Capacity hot water 40 °C at Normal comfort (V_{max})	litre	281
Dimensions and weight		
Width	mm	600
Depth	mm	616
Height	mm	2100-2125
Required headroom	mm	2270
Weight	kg	218
Part no.		625 06 72

¹ A20(12)W35, exhaust air flow 200 m³/h

² A20(12)W45, exhaust air flow 150 m³/h

³ A20(12)W55, exhaust air flow 110 m³/h

⁴ The value varies with the selected fan curve and the room's damping capacity. These values apply with a damping of 4 dB. For more extensive sound data including sound to channels visit www.nibe.eu.

⁵ A20(12) exhaust air flow 150 m³/h

SUPPLIED COMPONENTS

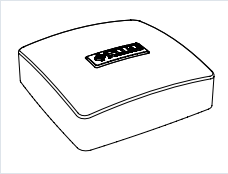

Outdoor temperature sensor

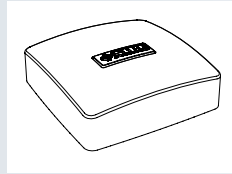

Indoor temperature sensor

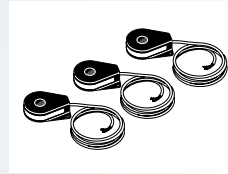

Current sensor

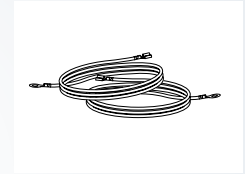

Earth cable

The kit of supplied items is placed on top of the heat pump.

ACCESSORIES

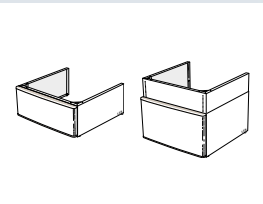

NIBE™ Top cabinet

Top cabinet for room height
2400, 2500, 2550-2800 mm.

Height: 2,400 mm
Part no. 089 756
Height: 2,500 mm
Part no. 089 757
Height: 2550-2800 mm

Part no. 089 758

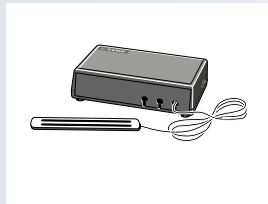

NIBE™ SMS 40

Communication module

NIBE SMS 40 enables controlling and monitoring of operations using text messages from a mobile phone via the GSM module.

Part no. 067 073

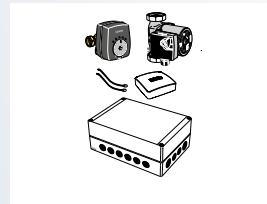

NIBE™ ECS 40/ ECS 41

Extra shunt group

This accessory is used when NIBE F470 is installed in houses with two or more different climate systems that require different supply temperatures, for example, in cases where the house has both a radiator system and an underfloor heating system.

ECS 40 Part no. 067 061
ECS 41 Part no. 067 099

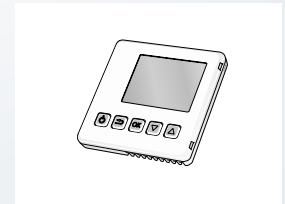

NIBE™ RMU 40

Room unit

NIBE RMU 40 allows control and monitoring of operations from other parts of a home other than where NIBE F470 is located.

Part no. 067 064

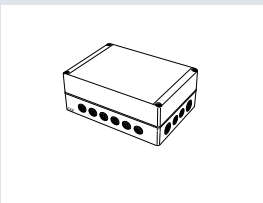

NIBE™ DEH 40/41

Docking kit

There are separate docking kits available for connecting other heat sources to the heat pump.

DEH 40
Docking kit wood/oil/pellets
Part no. 066 101
DEH 41
Docking kit gas
Part no. 066 102



NIBE™ UKVS 230

Accumulator tank

UKVS 230 is an accumulator tank with coil for solar panels. UKVS 230 is intended to be used for heat storage when a smaller heat pump is docked with solar panels.

Part no. 067 147

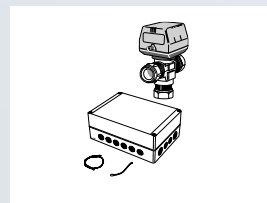

NIBE™ Solar 41

Solar heating

NIBE SOLAR 41 enables solar heating with your heat pump. It offers a complete system together with additional solar panels and UKVS 230.

Part no. 067 127

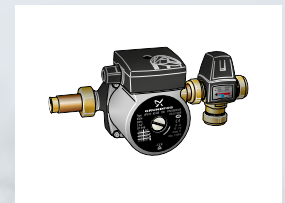

NIBE™ MCU 10

Multi charging unit

For use in the NIBE solar package with NIBE F370/F470.

Part no. 067 128



NIBE™ SPS 10

Solar pump station

For use in the NIBE solar package with NIBE F370/F470.

Part no. 057 027



NIBE is ISO-certified:
SS-EN ISO 9001:2000
SS-EN ISO 14001:2004

This brochure is a publication from NIBE. All product illustrations, facts and specifications are based on current information at the time of the publication's approval. NIBE makes reservations for any factual or printing errors in this brochure.
Photos: www.benfoto.se. ©NIBE 2012.



NIBE Energy Systems AB
Box 14
SE-285 21 Markaryd
SWEDEN
Tel: +46 433 - 73 000
www.nibe.eu