

Installer manual  
**NIBE F370**  
Exhaust air heat pump

## Quick guide

### Navigation

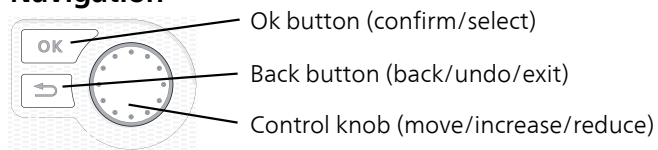

A detailed explanation of the button functions can be found on page 38.

How to scroll through menus and make different settings is described on page 40.

### Set the indoor climate

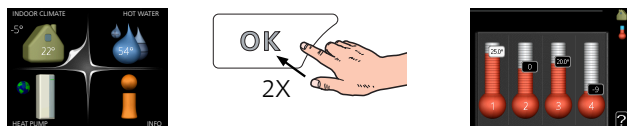

The mode for setting the indoor temperature is accessed by pressing the OK button twice, when in the start mode in the main menu.

### Increase hot water volume



To temporarily increase the amount of hot water, first turn the control knob to mark menu 2 (water droplet) and then press the OK button twice.

# Table of Contents

<b>1 Important information</b>	<b>4</b>	Menu 5 - SERVICE	44
Safety information	4		
General	10		
<b>2 Delivery and handling</b>	<b>12</b>	<b>9 Service</b>	<b>49</b>
Transport	12	Maintenance	49
Assembly	12	Service actions	49
Supplied components	13	<b>10 Disturbances in comfort</b>	<b>53</b>
Removing the covers	13	Info-menu	53
Removing parts of the insulation	13	Manage alarm	53
		Troubleshooting	53
<b>3 The heat pump design</b>	<b>14</b>	<b>11 Accessories</b>	<b>55</b>
Component positions	14		
_____	15	<b>12 Technical data</b>	<b>56</b>
<b>4 Pipe and ventilation connections</b>	<b>16</b>	Dimensions and setting-out coordinates	56
General pipe connections	16	Technical specifications	57
Dimensions and pipe connections	17	Energy labelling	61
Symbol key	18	Electrical circuit diagram	63
Cold and hot water	18	<b>Item register</b>	<b>75</b>
Heating medium side	18		
Installation alternative	19	<b>Contact information</b>	<b>79</b>
General ventilation connection	20		
Ventilation flow	20		
Adjusting ventilation	20		
<b>5 Electrical connections</b>	<b>21</b>		
General	21		
Connections	23		
Settings	26		
Optional connections	28		
Connecting accessories	31		
<b>6 Commissioning and adjusting</b>	<b>32</b>		
Preparations	32		
Filling and venting	32		
Start-up and inspection	33		
<b>7 Control - Introduction</b>	<b>38</b>		
Display unit	38		
Menu system	39		
<b>8 Control - Menus</b>	<b>42</b>		
Menu 1 - INDOOR CLIMATE	42		
Menu 2 - HOT WATER	42		
Menu 3 - INFO	42		
Menu 4 - HEAT PUMP	43		

# 1 Important information

## Safety information

This manual describes installation and service procedures for implementation by specialists.

The manual must be left with the customer.

This appliance can be used by children aged from 8 years and above and persons with reduced physical, sensory or mental capabilities or lack of experience and knowledge if they have been given supervision or instruction concerning use of the appliance in a safe way and understand the hazards involved. Children shall not play with the appliance. Cleaning and user maintenance shall not be made by children without supervision.

Rights to make any design or technical modifications are reserved.

©NIBE 2017.

## Symbols



### WARNING!

This symbol indicates serious danger to person or machine.



### NOTE

This symbol indicates danger to person or machine.



### Caution

This symbol indicates important information about what you should observe when maintaining your installation.



### TIP

This symbol indicates tips on how to facilitate using the product.

## Marking

**CE** The CE mark is obligatory for most products sold in the EU, regardless of where they are made.

**IP21** Classification of enclosure of electro-technical equipment.



Fire hazard!



Read the User Manual.



Read the Installer Manual.

## Handling

The heat pump contains highly flammable refrigerant. Special care should be exercised during handling, installation, service, cleaning and scrapping to avoid damage to the refrigerant system, and thereby reduce the risk of leakage.



### NOTE

Work on the refrigerant system must be carried out by authorised personnel, in accordance with the relevant legislation on refrigerants and supplemented by the additional requirements for flammable gas; for example, product knowledge as well as service instructions for gas systems with flammable gases.

## Safety precautions



### WARNING!

Do not use agents to speed up the defrosting process or for cleaning, other than those recommended by the manufacturer.

The apparatus must be stored in a room with no continuous ignition sources (e.g. naked flame, an active gas installation or an active electric heater).

Must not be punctured or burned.  
Be aware that the refrigerant may be odourless

## General

Pipe installation should be kept to a minimum.

### **Area checks**

Before work is started on systems that contains combustible refrigerants, safety checks must be performed to ensure that the ignition risk is kept to a minimum.

### **Working method**

The work must be carried out in a controlled way to minimise the risk of contact with combustible gas or liquid during the work.

### **General for the working range**

All maintenance staff and those who work in close proximity to the product must be instructed which type of work is to be carried out. Avoid carrying out work in enclosed spaces. The area surrounding the worksite must be cordoned off. Ensure that the area is made safe by removing combustible material.

### **Check for the presence of refrigerant**

Check whether there is refrigerant in the area using a suitable refrigerant detector prior to and during work, to notify the service technician whether there is a possible flammable atmosphere or not. Ensure that the refrigerant detector is suitable for combustible refrigerant, i.e. does not generate sparks or cause ignition in any other way.

### **Presence of fire extinguishers**

If hot work is carried out on the heat pump, a powder or carbon dioxide fire extinguisher must be to hand.

### **Absence of ignition sources**

Those who carry out work with refrigerant system connections, including exposing pipes that contain or have contained combustible refrigerant, may not use potential ignition sources in such a way that that can lead to risks of fire or explosions.

All potential ignition sources, including cigarette smoking, should be kept at a safe distance from the service work area where combustible refrigerant can leak out. Before carrying out work, the area surrounding the equipment must be checked to ensure that there are no ignition risks. "No smoking" signs must be displayed.

### **Ventilated area**

Ensure that the work is carried out outdoors or that the work area is ventilated before the system is opened and before any hot work is carried out. The area must be ventilated whilst the work is being carried out. There must be ventilation around any refrigerant that comes out, which should be routed outdoors.

### **Checking cooling equipment**

If electrical components are replaced, the replacement parts must be fit for purpose and have the correct technical specifications. Always follow the manufacturer's guidelines regarding maintenance and servicing. Contact the manufacturer's technical department in the event of any doubts.

The following checks must be carried out for installations that use combustible refrigerants.

- The filling quantity is appropriate for the size of the space where the parts that contain refrigerant are installed.
- Ventilation equipment and outlet work correctly and without obstructions.
- If an indirect refrigerant circuit is used, check whether the secondary circuit contains refrigerant.
- All markings of equipment are visible and clear. Markings, signs and similar that are not clear must be replaced.

- Refrigerant pipes and components are positioned in such a way that it is not likely that they be subjected to substances that can corrode components containing refrigerant, if these components are not made of material that is resistant against corrosion, or not appropriately protected against such corrosion.

### **Checking electrical equipment**

Repair and maintenance of electrical components must include initial safety checks and procedures for component inspection. In the event of a fault, which can cause a safety risk, do not supply any power to the circuit until the fault has been rectified. If the fault cannot be rectified immediately, and operation must continue, an adequate temporary solution must be implemented. This must be reported to the equipment owner, so that all parties have been informed.

The following checks must be carried out at the initial safety checks.

- That the capacitors are discharged. Discharging must be done safely, to prevent the risk of sparking.
- That no powered electrical components or live cables are exposed when filling or collecting refrigerant or when the system is flushed.
- That the system is continually earthed.

### **Repairing sealed components**

When repairing sealed components, all electrical supply must be disconnected from the equipment that is being repaired before any sealed covers or similar are removed. If it is absolutely necessary to have an electricity supply to the equipment during the service, continuously activated leak tracing must be performed at the most critical points in order to warn of any dangerous situations.

Pay particular attention to the following so that the sheath is not changed in a way that affects the protection level when working with electrical components. This means damage to cables, unnecessary amounts of connections, terminals that do not follow the original specifications, damaged gaskets, incorrect grommets etc.

Ensure that the apparatus is secured properly.

Check that seals or sealing materials have not deteriorated to a degree that they can no longer prevent combustible gases from entering. Replacement parts must meet the manufacturer's specifications.



#### **NOTE**

Use of silicone seals can hamper the efficiency of certain types of leak-tracing equipment. Components with built in safety do not need to be isolated before starting work.

### **Wiring**

Check that cabling will not be subject to wear, corrosion, excessive pressure, vibration, sharp edges or any other adverse environmental effects. The check shall also take into account the effects of aging or continual vibration from sources such as compressors or fans.

### **Leak testing**

The following leak detection methods are deemed acceptable for systems containing flammable refrigerants.

Electronic leak tracers must be used to detect combustible refrigerant; but the leak tracer may not be sufficiently sensitive or may need to be recalibrated (the leak tracing equipment must be calibrated in an area completely free from refrigerant). The leak tracer must not be a potential source of ignition and must be suitable for the

relevant refrigerant. The leak tracing equipment must be set and calibrated for the relevant refrigerant, to ensure that the gas concentration is a maximum of 25% of the lowest combustible concentration (Lower Flammability Limit, LFL) of the relevant refrigerant.

Leak detection fluids are suitable for use with most refrigerants but the use of detergents containing chlorine shall be avoided as the chlorine may react with the refrigerant and corrode the copper pipe-work.

If a leak is suspected, all naked flames shall be removed/extinguished.

If a leakage of refrigerant is found which requires brazing, all of the refrigerant shall be recovered from the system, or isolated (by means of shut off valves) in a part of the system remote from the leak. Oxygen free nitrogen (OFN) shall then be purged through the system both before and during the brazing process.

### **Removal and draining**

When a cooling circuit is opened for repairs – or for another reason – work must be carried out in a conventional manner. Due to the risk of fire it is important that best practice is applied. Follow the procedure below.

1. Drain the refrigerant.
2. Flush the circuit with inert gas.
3. Drain the circuit.
4. Flush again with inert gas.
5. Open the circuit by cutting or burning.

Collect the refrigerant in the intended container. Flush the system with oxygen-free nitrogen to make the device safe. This process may need to be repeated several times. Compressed air and oxygen may not be used.

Flush the system by breaking the vacuum with oxygen-free nitrogen, and filling the system to working pressure, relieving the pressure to atmospheric pressure and finally pumping to vacuum. Repeat the process until no refrigerant remains in the system. After the final filling of oxygen-free nitrogen, relieve the pressure in the system to atmospheric pressure, so that work can be carried out. This type of flushing must be carried out if hot work is to be performed on the pipe system.

Ensure that the vacuum pump's outlet is not near to ignition sources and that there is satisfactory ventilation by the outlet.

### **Filling**

In addition to the conventional filling procedures, the following actions must be taken.

- Ensure that different refrigerants are not mixed when filling equipment is used. Hoses and lines must be as short as possible to minimise the enclosed refrigerant volume.
- Containers must be stored upright.
- Ensure that the cooling system is grounded before the system is filled with refrigerant.
- Mark the system once filling is complete (if not already marked).
- Take extra care not to overfill the cooling system.

Before refilling the system, pressure test it with oxygen-free nitrogen. Leak test the system after filling but before using the system. Perform an additional leak test before leaving the installation.

### **Decommissioning**

Before performing this procedure, the technician must be familiar with the equipment and all its component parts.

Good practice prescribes that all refrigerant is collected safely. Before the work is carried out, samples of oil and refrigerant must be taken, if analyses are required before collected refrigerant can be reused. There must be a power supply when this task is started.

1. Familiarise yourself with the equipment and its use.
2. Isolate the system electrically.
3. Before starting the procedure, ensure that:
  - necessary equipment for mechanical handling of the refrigerant container is available
  - all necessary personal safety equipment is available and used correctly
  - the collection process is continuously supervised by an authorised person
  - the collection equipment and containers meet appropriate standards.
4. Pump the refrigerant system to vacuum, if possible.
5. If it is not possible to pump to vacuum, manufacture a branch, so that the refrigerant can be retrieved from different parts of the system.
6. Check that the refrigerant container is on the scales before starting to collect.
7. Start the collection device and collect according to the manufacturer's instructions.
8. Do not overfill the containers (max. 80 % (volume) liquid content).
9. Do not exceed the containers' maximum permitted working pressure – not even temporarily.
10. When the containers have been filled correctly and the process is complete, close all shut-off valves in the equip-

ment and remove and containers and equipment from the installation immediately.

11. The collected refrigerant must not be filled in any other system before being cleaned and checked.

### **Marking**

The equipment must be marked stating that it has been taken out of operation and drained of refrigerant. The marking must be dated and signed. Check that the equipment is marked indicating that it contains combustible refrigerant.

### **Collection**

Best practice prescribes that all refrigerant is collected safely when the refrigerant is drained from a system, either for servicing or for decommissioning.

The refrigerant must only be collected in suitable refrigerant containers. Ensure that the required number of containers, that can hold the entire volume of the system, are available. All containers that are to be used must be intended for the collection of the refrigerant and marked for this refrigerant (especially designed for the collection of refrigerant). The containers must have the correctly functioning relief valves and shut-off valves. Empty collection containers must be drained and, if possible, chilled before collection.

The collection equipment must function correctly and instructions for the equipment must be to hand. The equipment must be suitable for the collection of combustible refrigerant.

Fully functioning and calibrated scales must also be to hand.

Hoses must be in good condition and be equipped with leak proof quick-couplings. Before using the collecting machine, check that it works correctly and has been well



maintained, and that corresponding electrical components are sealed, to prevent ignition if any refrigerant should come out. Contact the manufacturer in the event of any doubts.

Return the collected refrigerant to the refrigerant supplier in the correct collection container and with the relevant Waste Transfer Note. Do not mix refrigerants in collection devices or containers.

If compressors/compressor oil are/is to be removed ensure that the affected device is drained to an acceptable level to ensure that no combustible refrigerant remains in the lubricant. Compressors must be drained before being returned to the supplier. Only electrical heating of the compressor housing may be used to quicken draining. Drain oil from the system in a safe manner.

### ***Miscellaneous***

Maximum amount of refrigerant: See Technical specifications.

- Everyone who works with or opens a refrigerant circuit must have a current, valid certificate from an accredited industry issuing body, which states that, according to the industry's recognised assessment standard, they have the authority to safely handle refrigerants.
- Servicing must only be performed according to the equipment manufacturer's recommendations.

Maintenance and repairs that require the assistance of another trained person must be carried out under the supervision of person with the authority to handle combustible refrigerants.

Maintenance and repair that requires the skill of another person must be carried out under the supervision of someone with the above expertise.

## General

### Serial number

The serial number can be found at the bottom right of the front cover and in the info menu (menu 3.1).

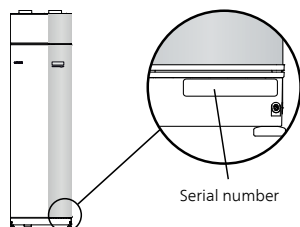

#### Caution

You need the product's (14 digit) serial number for servicing and support.

### Recovery



Leave the disposal of the packaging to the installer who installed the product or to special waste stations.

Do not dispose of used products with normal household waste. It must be disposed of at a special waste station or dealer who provides this type of service.

Improper disposal of the product by the user results in administrative penalties in accordance with current legislation.

## Inspection of the installation

Current regulations require the heating installation to be inspected before it is commissioned. The inspection must be carried out by a suitably qualified person. In addition, fill in the page for the installation data in the User Manual.

✓	Description	Notes	Signature	Date
	Ventilation (page 20)			
	Setting the ventilation flow			
	Connecting ground cables			
	Heating medium (page 18)			
	System flushed			
	System vented			
	Safety valve			
	Circulation pump setting			
	Setting heating medium flow			
	Boiler pressure			
	Electricity (page 21)			
	Connections			
	Main voltage			
	Phase voltage			
	Fuses heat pump			
	Fuses property			
	Outside sensor			
	Room sensor			
	Current sensor (only copper version)			
	Safety breaker			
	Earth circuit-breaker			

## 2 Delivery and handling

### Transport

F370 should be transported and stored vertically in a dry place. However, the F370 may be carefully laid on its back when being moved into a building. The centre of gravity is in the upper part.

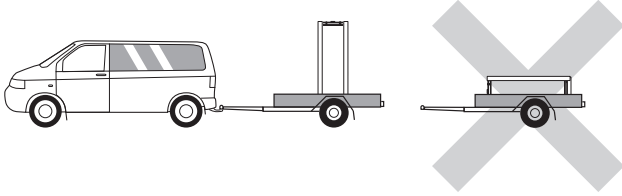

### Assembly

- Position F370 on a fixed foundation that can take the weight of the heat pump. Use the product's adjustable feet to obtain a horizontal and stable set-up.

Because water comes from F370, the floor coating is important. A waterproof floor or floor membrane is recommended.

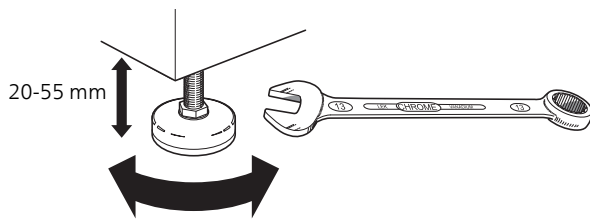

- Because water comes from F370, it is good if the area where the heating pump is located is provided with floor drainage.
- Install with its back to an outside wall, ideally in a room where noise does not matter, in order to eliminate noise problems. If this is not possible, avoid placing it against a wall behind a bedroom or other room where noise may be a problem.
- Wherever the unit is located, walls to sound sensitive rooms should be fitted with sound insulation.
- Route pipes so they are not fixed to an internal wall that backs on to a bedroom or living room.
- The heat pump's installation area should always have a temperature of at least 10 °C and max 30 °C.

### Installation area

Leave a free space of 800 mm in front of the product. Leave free space between F370 and wall/other machinery/fittings/cables/pipes etc. It is recommended that a space of at least 10 mm is left to reduce the risk of noise and of any vibrations being propagated.

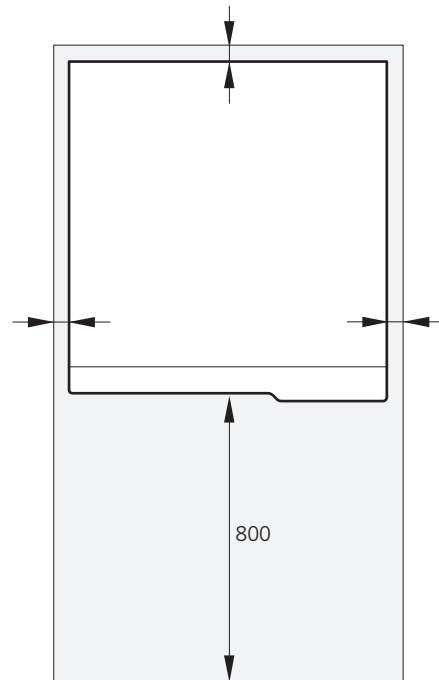

#### NOTE

Ensure that there is sufficient space (300 mm) above the heat pump for installing ventilation hoses.

## Supplied components

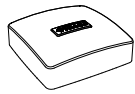

Outside sensor

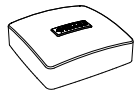

Room sensor



Earth cabling (2 pcs)



Current sensor

### Location

The kit of supplied items is placed on top of the product.

## Removing the covers

### Front cover

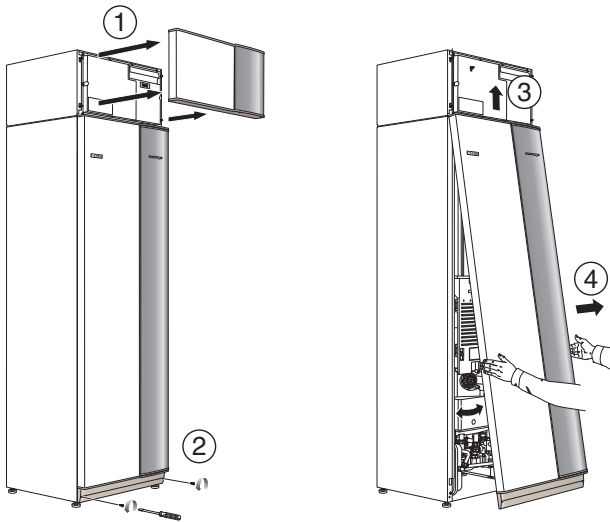

1. Remove the upper panel by pulling it straight out.
2. Remove the screws from the lower edge of the front panel.
3. Lift the panel out at the bottom edge and up.
4. Pull the panel towards yourself.

### Side covers

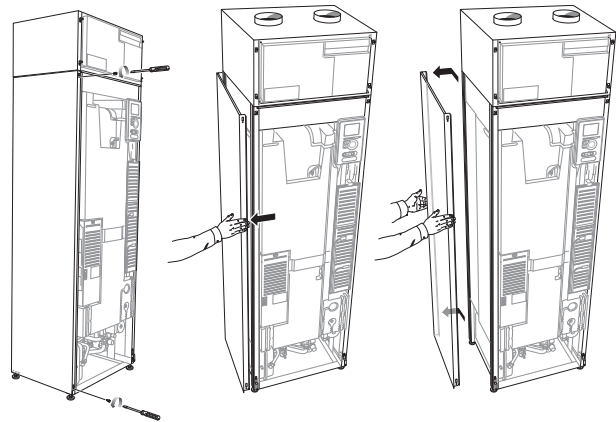

The side covers can be removed to facilitate the installation.

1. Remove the screws from the upper and lower edges.
2. Twist the cover slightly outward.
3. Move the hatch backwards and slightly to the side.
4. Pull the cover to one side.
5. Pull the hatch forwards.

## Removing parts of the insulation

Parts of the insulation can be removed to facilitate the installation.

Grip the handle and pull straight out as illustrated.

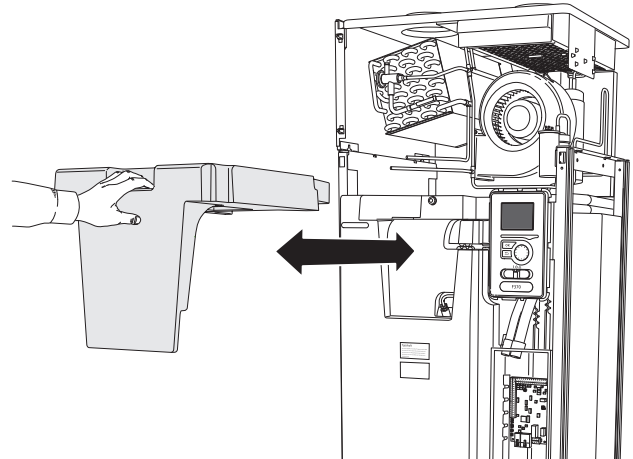

# 3 The heat pump design

## Component positions

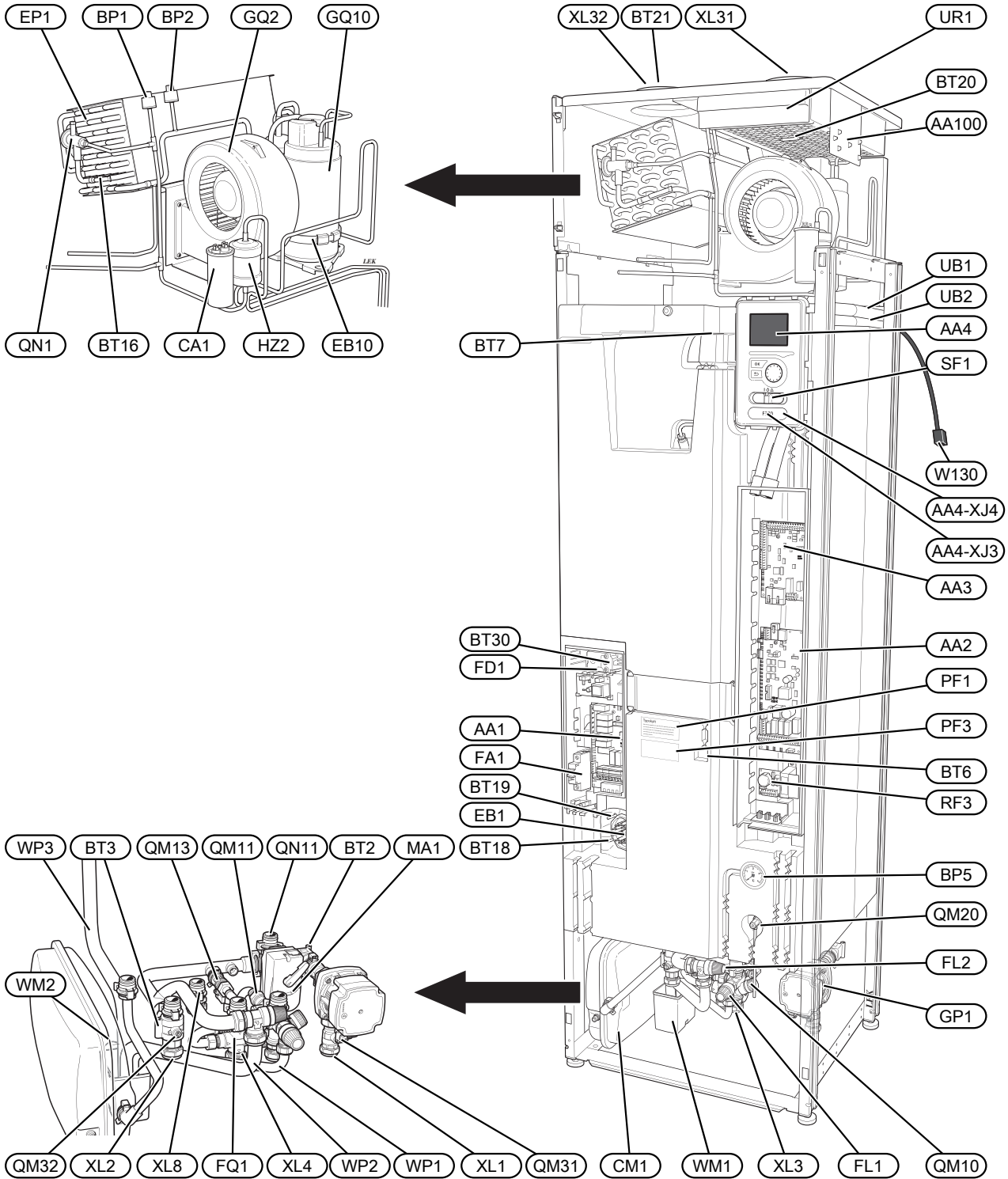

## Pipe connections

XL1	Connection, heating medium flow line
XL2	Connection, heating medium return line
XL3	Connection, cold water
XL4	Connection, hot water
XL8	Connection, docking in
XL31	Ventilation connection, exhaust air
XL32	Ventilation connection, extract air

## HVAC components

CM1	Expansion vessel
FL1	Safety valve, water heater
FL2	Safety valve, climate system
FQ1	Mixer valve, hot water
GP1	Circulation pump
QM10	Filler valve, hot water heater
QM11	Filler valve, climate system
QM13	Filler valve 2, climate system
QM20	Venting, heating medium
QM31	Shut-off valve, heating medium flow
QM32	Shut off valve, heating medium return
QN11	Shunt valve
WM1	Overflow cup
WM2	Overflow water discharge
WP1	Overflow pipe, safety valve hot water heater
WP2	Overflow pipe, safety valve climate system
WP3	Overflow pipe, condensation

## Sensors etc.

BF1	Flow sensor (located on the rear of the machine) <sup>3</sup>
BP1	High pressure pressostat
BP2	Low pressure pressostat
BP5	Pressure gauge, heating system
BT1	Outside sensor <sup>1</sup>
BT2	Temperature sensors, heating medium flow
BT3	Temperature sensors, heating medium return
BT6	Temperature sensor, hot water, control
BT7	Temperature sensor, hot water, display
BT16	Temperature sensor, evaporator <sup>1</sup>
BT18	Temperature sensor, compressor operation
BT19	Temperature sensor, immersion heater operation
BT20	Temperature sensor, exhaust air
BT21	Temperature sensor, extract air
BT30	Thermostat, backup heating
BT50	Room sensor <sup>1</sup>

## Electrical components

AA1	Immersion heater card
AA2	Base card
AA3	Input circuit board

AA4	Display unit
	AA4-XJ3 USB socket
	AA4-XJ4 Service socket
AA100	Connection card air treatment section, exhaust air
CA1	Capacitor
EB1	Immersion heater
EB10	Compressor heater
FA1	Miniature circuit-breaker
FA2	Miniature circuit-breaker
FD1	Temperature limiter
MA1	Shunt motor with hand wheel
RF3	EMC-filter
SF1	Switch
W130	Network cable for NIBE Uplink™

## Cooling components

EP1	Evaporator
GQ10	Compressor
HZ2	Drying filter <sup>1</sup>
QN1	Expansion valve <sup>1</sup>

## Ventilation

GQ2	Exhaust air fan
HQ10	Exhaust air filter <sup>1</sup>
UR1	Filter cover, exhaust air

## Miscellaneous

PF1	Rating plate
PF3	Serial number plate
UB1-2	Cable gland

<sup>1</sup>Not visible in the image

Designations in component locations according to standard IEC 81346-1 and 81346-2.

# 4 Pipe and ventilation connections

## General pipe connections

Pipe installation must be carried out in accordance with current norms and directives.

The system requires the radiator circuit to be designed for a low temperature heating medium. At the lowest dimensioned outdoor temperature (DOT) the highest recommended temperatures are 55 °C on the supply line and 45 °C on the return line.

Overflow water from the evaporator collection tray and safety valves passes via a non-pressurised pipe to an overflow cup, and from there to a drain, so that hot water splashes cannot cause injury. The entire length of the overflow water pipe must be inclined to prevent water pockets and must also be frost-proof.

**NOTE**

The pipe system needs to be flushed out before the heat pump is connected so that any debris cannot damage component parts.

**Caution**

Ensure that incoming water is clean. When using a private well, it may be necessary to supplement with an extra water filter.

### Maximum boiler and radiator volumes

The volume of the pressure expansion vessel (CM1) is 10 litres and it is pre-pressurised as standard to 0.5 bar (5 mvp). As a result, the maximum permitted height "H" between the vessel and the highest radiator is 5 m, see figure.

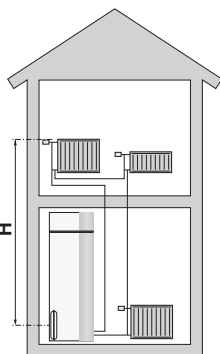

If the standard initial pressure in the pressure vessel is not high enough it can be increased by adding air via the valve in the expansion vessel. The initial pressure of the expansion vessel must be stated in the inspection document. Any change in the initial pressure affects the ability of the expansion vessel to handle the expansion of the water.

The maximum system volume excluding the boiler is 219 litres at the above pre-pressure.

### System diagram

F370 consists of a heat pump, water heater, immersion heater, fan, circulation pump and control system. F370 is connected to the ventilation system and heating medium circuits.

When the exhaust air at room temperature passes through the evaporator, the refrigerant evaporates because of its low boiling point. In this way the energy in the room air is transferred to the refrigerant.

The refrigerant is then compressed in a compressor, causing the temperature to rise considerably.

The warm refrigerant is led to the condenser. Here the refrigerant gives off its energy to the heating system water, whereupon the refrigerant changes state from gas to liquid.

The refrigerant then goes via filters to the expansion valve, where the pressure and temperature are reduced.

The refrigerant has now completed its circulation and returns to the evaporator.

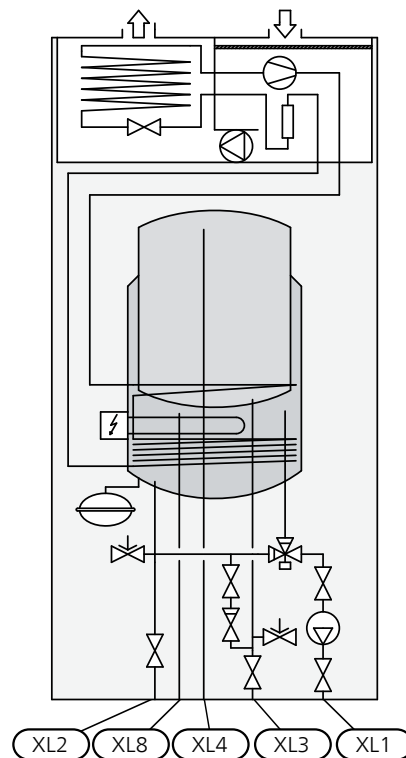

- XL1 Connection, heating medium flow
- XL2 Connection, heating medium return
- XL3 Connection, cold water
- XL4 Connection, hot water
- XL8 Connection, docking

**Caution**

This is an outline diagram, differences may occur in the actual installation.



## Dimensions and pipe connections

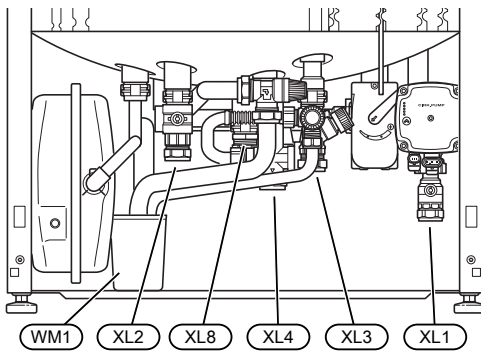
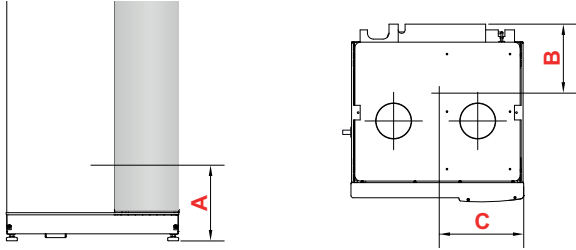













## Setting out dimensions

Connection		A	B	C
XL1 Heating medium supply	(mm)	135	360	65
XL2 Heating medium return	(mm)	215	425	385
XL3 Cold water	(mm)	200	455	215
XL4 Hot water	(mm)	180	405	265
XL8 Docking	(mm)	220	290	300
WM1 Overflow cup	(mm)	95	205	430

## Pipe dimensions

Connection		
XL1-XL2 Heating medium ext Ø	(mm)	22
XL3 Cold water ext Ø	(mm)	22
XL4 Hot water ext Ø	(mm)	22
XL5 Hot water circulation ext. Ø	(mm)	15
XL8 Docking ext. Ø	(mm)	22
WM2 Overflow water discharge	(mm)	32

## Symbol key

Symbol	Meaning
	Shut-off valve
	Non-return valve
	Mixing valve
	Shunt / shuttle valve
	Safety valve
	Temperature sensor
	Circulation pump
	Particle filter
	Radiator system
	Domestic hot water
	Under floor heating systems
	Hot water circulation

## Cold and hot water

### Connecting cold and hot water

- The setting for hot water is made in menu 5.1.1 (page 45).

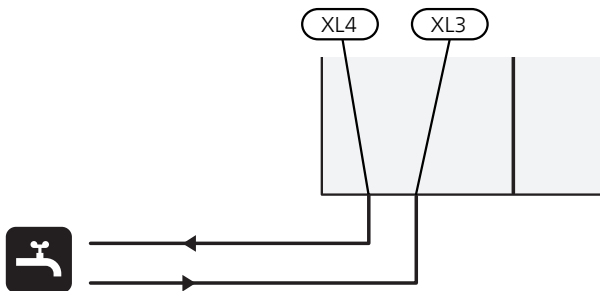

## Heating medium side

### Connecting the climate system

A climate system is a system that regulates indoor comfort with the help of the control system in F370 and for example radiators, under floor heating/cooling, fan coils etc.

- When connecting to a system with thermostats on all radiators, a relief valve must be fitted, or some of the thermostats must be removed to ensure sufficient flow.

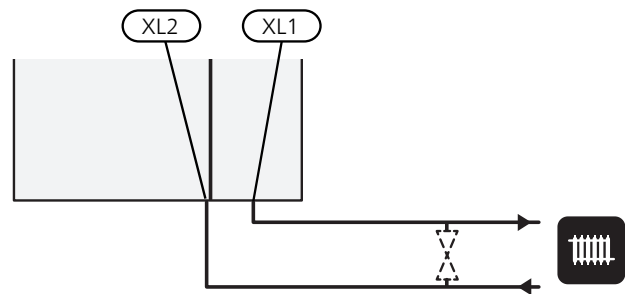

## Installation alternative

F370 can be installed in several different ways, some of which are shown below.

Further option information is available at [www.nibe.eu](http://www.nibe.eu) and in the respective assembly instructions for the accessories used. See page 55 for a list of the accessories that can be used with F370.

### Extra hot water heaters

The heat pump should be supplemented with an extra water heater, if a large bath tub or other significant consumer of hot water is installed.

### Water heater with immersion heater

If it is possible to use a water heater with an immersion heater, NIBE COMPACT or EMINENT type water heaters can be used.

If the valve connector is to be installed externally, moved out or separated, it must be replaced with a separable connector  $\varnothing$  22 mm.

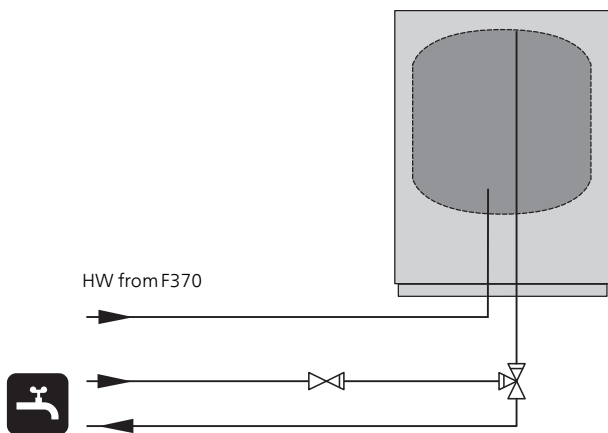

## Hot water circulation (VVC)

To reduce the risk of bacterial growth in systems with hot water circulation, the temperature of the circulating water should not fall below 50°C. Nor should there be any hot water pipes containing stationary water. Adjust the hot water system so that the temperature does not fall below 50°C at the extremities of the system.

The circulation pump for hot water circulation can be controlled by the heat pump. The HWC return can be connected to a freestanding water heater.

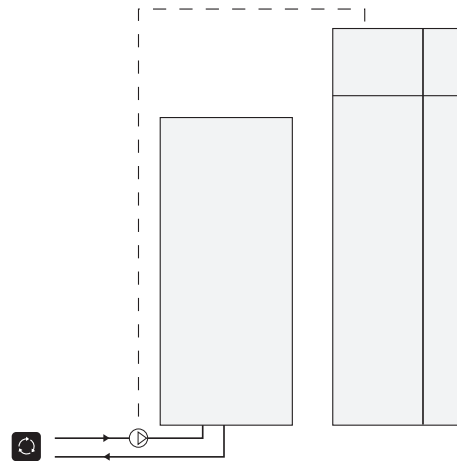

## Two or more climate systems

When more than one climate system is to be heated, the following connection can be used.

The ECS 40/ECS 41 accessory is required for this connection.

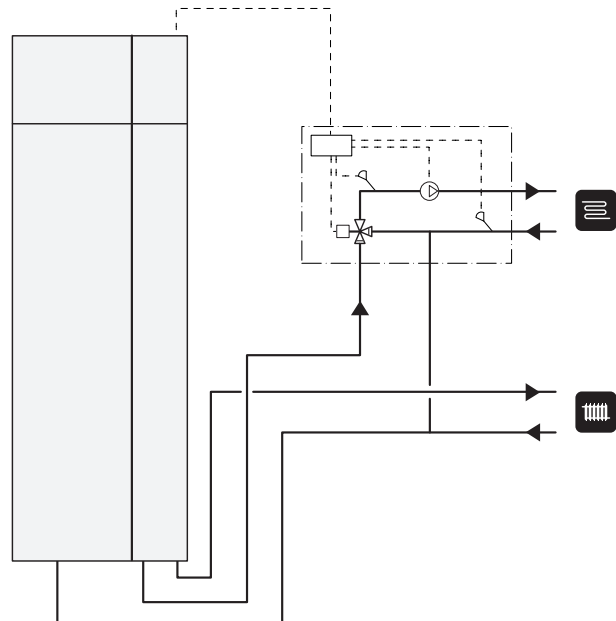

## General ventilation connection

Ventilation installation must be carried out in accordance with current norms and directives.

To prevent fan noise being transferred to the ventilation devices, silencers should be installed in the duct system. In the event of ventilation devices in noise-sensitive rooms, silencers must be installed.

Connections must be made via flexible hoses, which should be installed so that they are easy to replace. The extract air duct must be provided with diffusion-tight insulation (PE30) along its entire length. Ensure that the condensation insulation is fully sealed at any joints and/or at lead-in nipples, silencers, roof cowls or similar. Provision must be made for inspection and cleaning of the duct. Make sure that there are no reductions of cross-sectional area in the form of creases, tight bends, etc., since this will reduce the ventilation capacity. The duct system must be a minimum of air tightness class B. The extract air duct must be a maximum of 20 m long with a maximum of six bends.

Because the heat pump contains the flammable refrigerant propane (R290), the air ducting system must be earthed. This is done by making a sound electrical connection to the exhaust air and vented air ducts with the enclosed earth cables (2 pcs). The cables must then be connected to the earth pins on top of the top cover.

### Exhaust air duct /kitchen fan

Exhaust air duct (kitchen fan) must not be connected to F370.

To prevent food vapour being transferred to F370 the distance between the kitchen fan and the exhaust air device must be considered. The distance should not be less than 1.5 m, but this can vary between different installations.

Always use a kitchen fan when cooking.



#### NOTE

A duct in a masonry chimney stack must not be used for extract air.

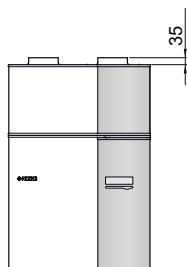
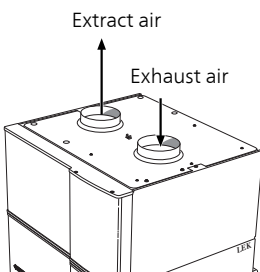

## Ventilation flow

Connect F370 so that all of the exhaust air, except kitchen duct air (kitchen fan), passes the evaporator (EP1) in the heat pump. The lowest ventilation flow must comply with the applicable national standards. For optimum heat pump performance, the ventilation flow should not be less than 28 l/s (100 m<sup>3</sup>/h) at an exhaust air temperature of at least 20°C. When the exhaust air temperature is lower than 20°C (for example at start-up and when there is nobody at home), the minimum value is 31 l/s (110 m<sup>3</sup>/h).

The heat pump's installation area must be ventilated to at least 5 l/s (18 m<sup>3</sup>/h)

Ensure that the ventilation openings are not blocked. Set the ventilation capacity in the heat pump's menu system (menu 5.1.5).

(menu 5.1.5)

If the exhaust air temperature falls below 16 °C, the compressor is blocked and electric additional heat is permitted. Heat is not recovered from the exhaust air when the compressor is blocked.

## Adjusting ventilation

To obtain the necessary air exchange in every room of the house, the exhaust air devices must be correctly positioned and adjusted and the fan in the heat pump adjusted.

Immediately after installation adjust the ventilation so that it is set according to the projected value of the house.

Incorrect ventilation adjustment may lead to reduced installation efficiency and thus poorer operating economy, and may result in moisture damage to the house.

# 5 Electrical connections

## General

All electrical equipment, except the outdoor sensors, room sensors and the current sensors are ready connected at the factory.

- Disconnect the heat pump before insulation testing the house wiring.
- F370 is not switchable between 3x230V and 3x400V.
- F370 must be equipped with a separate earth-fault breaker (30 mA).
- If a miniature circuit breaker is used, this should have at least motor characteristic "C". See table on page 26 for fuse size.
- For the heat pump wiring diagram, see page 63.
- Communication and sensor cables to external connections must not be laid close to high current cables.
- The minimum area of communication and sensor cables to external connections must be 0.5 mm<sup>2</sup> up to 50 m, for example EKKX or LiYY or equivalent.
- When cable routing in F370, cable grommets UB1 and UB2, (marked in image) must be used. In UB1 and UB2 the cables are inserted through the heat pump from the back to the front. For dimensions diagram see page 23.

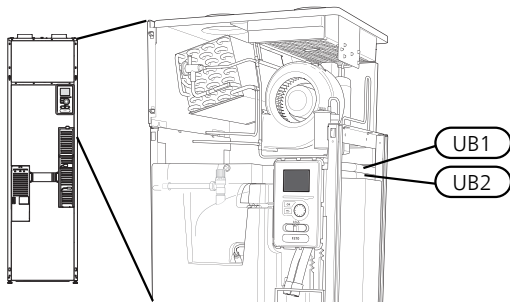

### NOTE

Switch (SF1) must not be moved to "I" or "△" until F370 has been filled with water. Otherwise the temperature limiter, thermostat and the immersion heater may be damaged.



### NOTE

Check the connections, main voltage and phase voltage before the machine is started, to prevent damage to the heat pump electronics.



### NOTE

If the supply cable is damaged, only NIBE, its service representative or similar authorised person may replace it to prevent any danger and damage.



### NOTE

Electrical installation and service must be carried out under the supervision of a qualified electrician. Cut the current with the circuit breaker before carrying out any servicing. Electrical installation and wiring must be carried out in accordance with the stipulations in force.

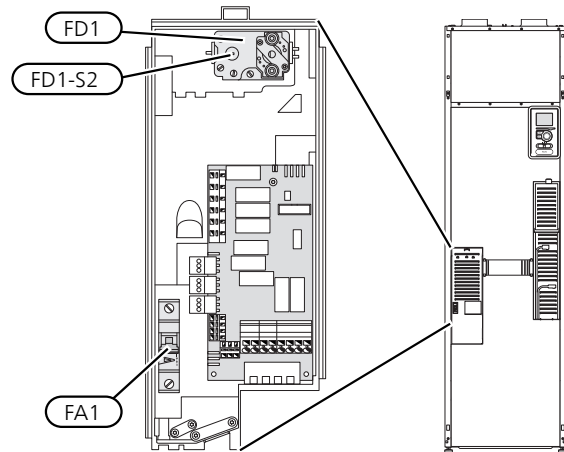

### Miniature circuit breaker (FA1)

Control (230 V), fan, compressor, circulation pump etc. are internally fused by a miniature circuit breaker (FA1).



### Caution

Check the miniature circuit-breaker (FA1). It may have tripped during transportation.

### Temperature limiter (FD1)

The temperature limiter (FD1) cuts the current supply to the electric additional heat if the temperature rises between 90 and 100°C and can be manually reset.

### Resetting

The temperature limiter (FD1) is accessible behind the front cover. Reset the temperature limiter by carefully pressing the button (FD1-SF2) using a small screwdriver.

## Accessibility, electrical connection

The plastic cap of the electrical boxes is opened using a screwdriver.



### NOTE

The cover for the input card is opened without a tool.

### Removing the cover, input board

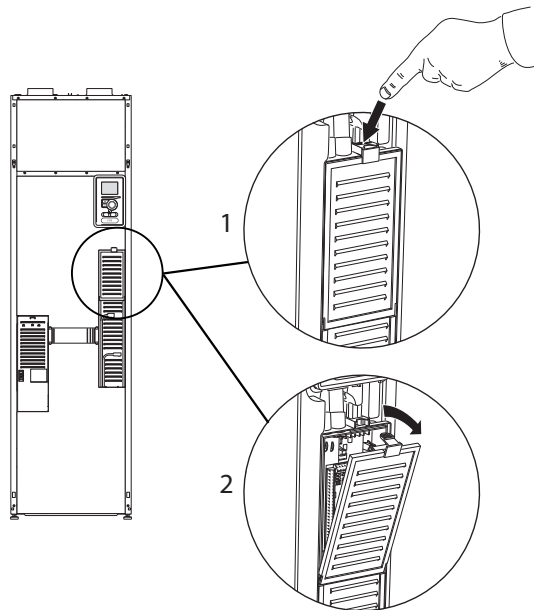

1. Push the catch down.
2. Angle out the cover and remove it.

### Removing the cover, immersion heater board

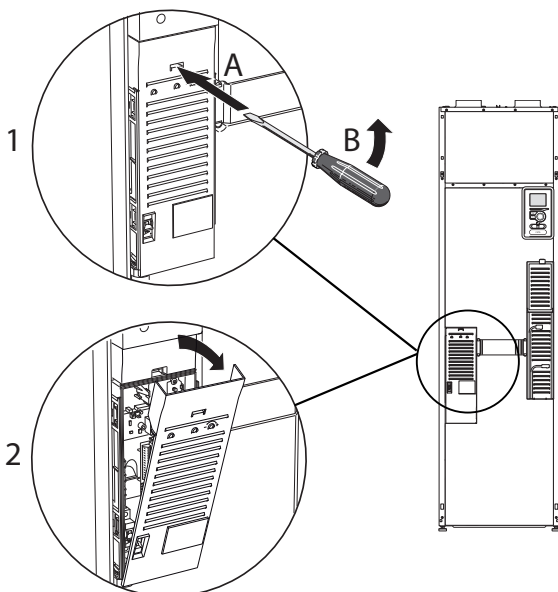

1. Insert the screwdriver (A) and pry the catch carefully downwards (B).
2. Angle out the cover and remove it.

### Removing the cover, base circuit board



### Caution

To remove the cover for the base board, the cover for the input circuit board must first be removed.

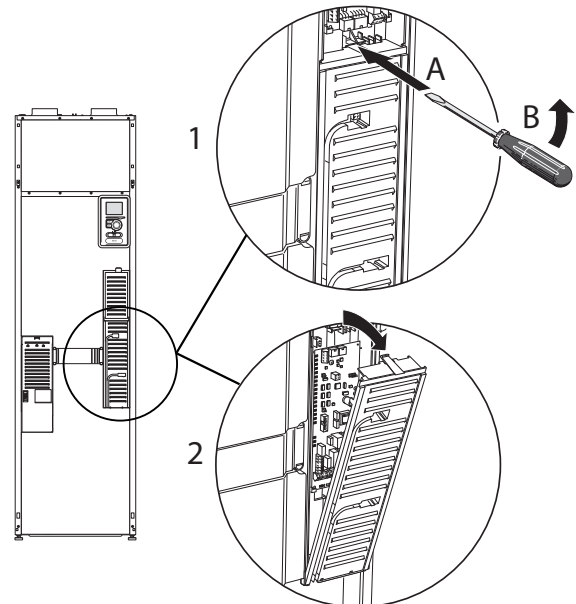

1. Insert the screwdriver (A) and pry the catch carefully downwards (B).
2. Angle out the cover and remove it.

### Cable lock

Use a suitable tool to release/lock cables in the heat pump terminal blocks.

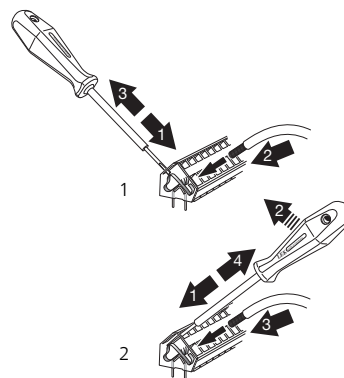

# Connections

**NOTE**

To prevent interference, unscreened communication and/or sensor cables to external connections must not be laid closer than 20 cm from high voltage cables.

## Power connection

F370 must be installed via an isolator switch with a minimum breaking gap of 3mm. Minimum cable area must be sized according to the fuse rating used. Supplied cable (length approx. 2 m) for incoming supply electricity is connected to terminal block X1 on the immersion heater board (AA1). The connection cable can be found on the back of F370 (see dimensions diagram below).

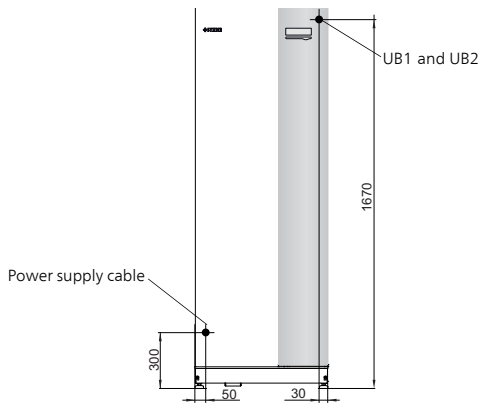

**NOTE**

F370 is not switchable between 3x230V and 3x400V.

## Connection 3x400V

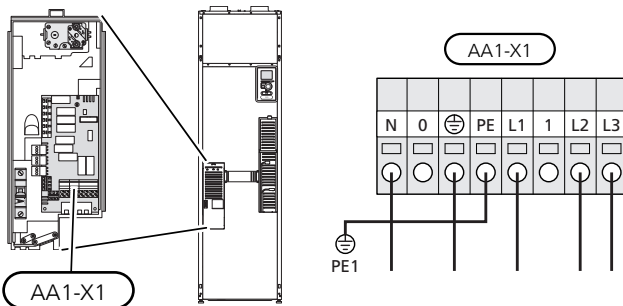

## Connection 3x230V

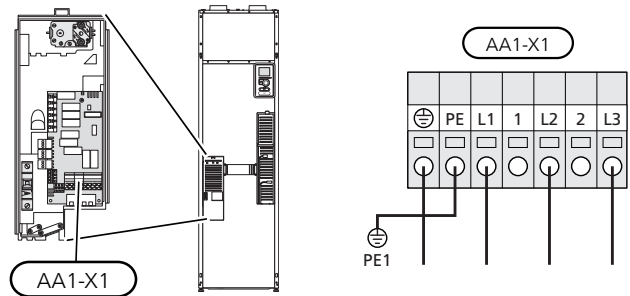

If separate supply to the compressor and immersion heater is required, see section "Possible selection for AUX inputs" on page 29.

## Tariff control

If the voltage to the immersion heater and/or the compressor disappears for a certain period, there must also be blocking via the AUX-input at the same time, see "Possible selection for AUX inputs".

## Connecting external operating voltage for the control system



### NOTE

Only applies to power connection of 3x400V.



### NOTE

Mark up any junction boxes with warnings for external voltage.

If you wish to connect external operating voltage for the control system to F370 on the immersion heater circuit board (AA1) the edge connector at AA1:X2 must be moved to AA1:X9 (as illustrated).

When connecting external operating voltage for the control system with separate earth-fault breaker, disconnect the blue cable from terminal block X7:24 on the immersion heater circuit board (AA1) and connect in the enclosed top clamp together with the incoming operating zero. Connect a blue cable (min 0.75 mm<sup>2</sup>) between the top clamp and X11:N on the immersion heater circuit board (as illustrated).

Operating voltage (230VAC) is connected to AA1:X11 (as illustrated).

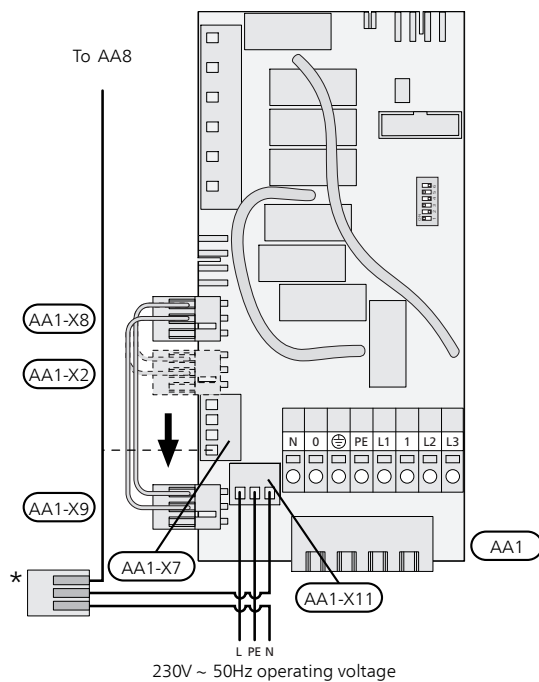

\* Only with separate earth-fault breaker.

## Switching from 3x400 V to 1x230 V

F370 can be switched from 3x400 V to 1x230 V by connecting the supply to L1 and L3.

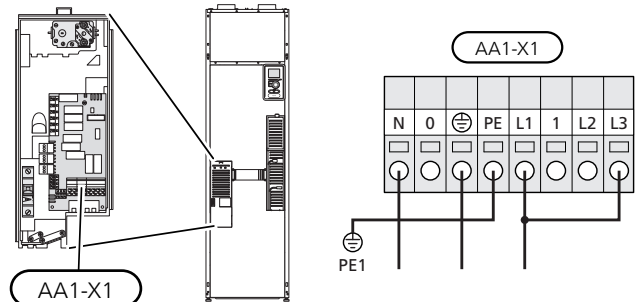

## Outside sensor

Install the outdoor temperature sensor (BT1) in the shade on a wall facing north or north-west, so it is unaffected by the morning sun for example.

Connect the sensor to terminal block X6:1 and X6:2 on the input board (AA3). Use a twin core cable of at least 0.5 mm<sup>2</sup> cable area.

If a conduit is used it must be sealed to prevent condensation in the sensor capsule.

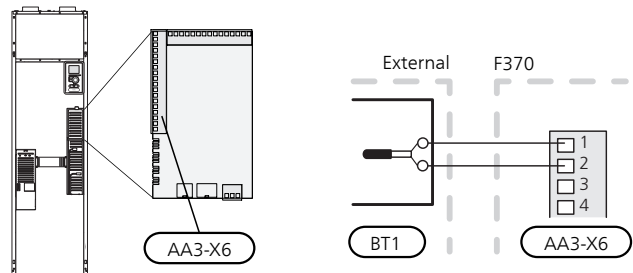



## Room sensor

F370 is supplied with a room sensor enclosed (BT50). The room sensor has up to three functions:

1. Show current room temperature in F370's display.
2. Option of changing the room temperature in °C.
3. Makes it possible to change/stabilise the room temperature.

Install the sensor in a neutral position where the set temperature is required. A suitable location is on a free inner wall in a hall approx. 1.5 m above the floor. It is important that the sensor is not obstructed from measuring the correct room temperature by being located, for example, in a recess, between shelves, behind a curtain, above or close to a heat source, in a draft from an external door or in direct sunlight. Closed radiator thermostats can also cause problems.

The heat pump operates without the sensor, but if one wishes to read off the accommodation's indoor temperature in F370's display, the sensor must be installed. Connect the room sensor to X6:3 and X6:4 on the input board (AA3).

If the sensor is to be used to change the room temperature in °C and/or to change/stabilise the room temperature, the sensor must be activated in menu 1.9.4.

If the room sensor is used in a room with underfloor heating, it should only have an indicative function, not control of the room temperature.

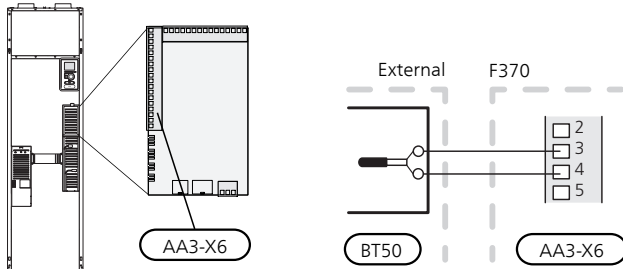

### Caution

Changes of temperature in accommodation take time. For example, short time periods in combination with underfloor heating will not give a noticeable difference in room temperature.

## Settings

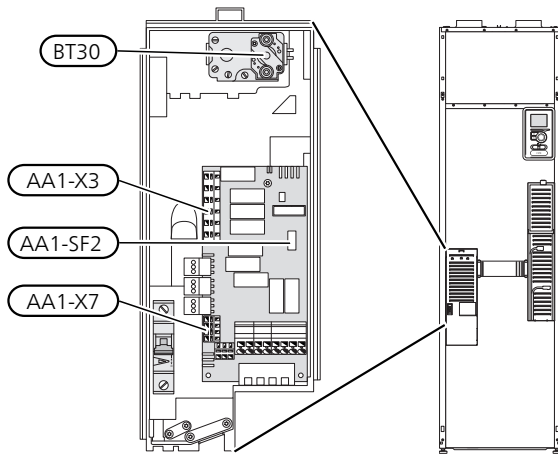

### Electrical addition - maximum output

The immersion heater output is divided into steps, according to the table.

Setting maximum output in the electric additional heat is done in menu 5.1.12.

When switching from 3x400 V to 1x230 V, the immersion heater is limited to 2 kW. Min. fuse rating 16 A.

### Power steps of the immersion heater

#### 3x400V

Electrical addition (kW)	Max (A) L1	Max (A) L2	Max (A) L3
0.0	5.3	-	-
2.0	5.3	-	8.7
4.7	5.3	11.6	8.7
5.6*	5.3	11.6	11.6
8.0	16.9	11.6	11.6
10.3	16.9	12.7	20.3

\*Factory setting

The table displays the maximum phase current for the relevant power step for the heat pump.

If the current sensors are connected, the heat pump monitors the phase currents and allocates the electrical steps automatically to the least loaded phase.

#### 3x230V

Electrical addition (kW)	Max (A) L1	Max (A) L2	Max (A) L3
0.0	3.9	3.9	-
2.0	3.9	11.2	8.7
4.7	14.0	11.2	17.6
6.7*	14.0	19.6	25.3
8.0	23.6	23.6	20.1
10.0	23.6	31.1	28.0

\*Factory setting

The table displays the maximum phase current for the relevant power step for the heat pump.

If the current sensors are connected, the heat pump monitors the phase currents and allocates the electrical steps automatically to the least loaded phase.

### Output locking

F370 follows applicable building regulations (BBR). This means that the maximum power output (maximum installed electrical output for heating) can be locked in menu 5.1.13. To then change the maximum power output, parts of the product must be replaced.

### Emergency mode

When the heat pump is set to emergency mode (SF1 is set to  $\Delta$ ), only the most necessary functions are activated.

- The compressor is off and heating is managed by the immersion heater.
- The load monitor is not connected.

### Power in emergency mode

The immersion heater's output in emergency mode is set with the dipswitch (S2) on the immersion heater circuit board (AA1) according to the table below.

When installing according to current building regulations (BBR) the immersion heater's power in emergency mode must be set to the maximum permitted electrical output.

#### 3x400V

kW	1	2	3	4	5	6
2.0	off	off	off	off	off	on
4.7	off	off	on	off	off	on
5.3	off	off	on	off	on	off
8.0*	on	off	on	off	on	off
10.3	on	off	on	on	on	on

\*Default value

### 3x230V

kW	1	2	3	4	5	6
2.0	off	off	on	off	off	off
4.7	off	off	off	on	on	off
6.7	off	off	on	on	on	off
8.0*	on	on	off	on	off	off
10.0	on	on	off	on	on	off

\*Factory setting

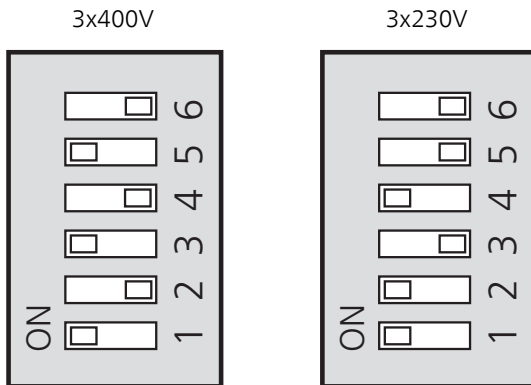

The image shows the dip-switch (AA1-S2) in the factory setting.

# Optional connections

## Load monitor

### Integrated load monitor

F370 is equipped with a simple form of integrated load monitor, which limits the power steps for the electric additional heat by calculating whether future power steps can be connected to the relevant phase without the specified main fuse being exceeded. In those cases where the current would exceed the specified main fuse, the power step is not permitted. The size of the property's main fuse is specified in menu 5.1.12.

### Load monitor with current sensor

When many power-consuming products are connected in the property at the same time as the electric additional heat is in operation, there is a risk of the property's main fuses tripping. F370 is equipped with a load monitor that, with the aid of current sensors, controls the power steps for the electric additional heat by redistributing the power between the different phases or disengaging the electric additional heat in event of an overload in a phase. Reconnection occurs when other current consumption is reduced.

### Connecting current sensors

A current sensor should be installed on each incoming phase conductor in to the distribution box to measure the current. The distribution box is an appropriate installation point.

Connect the current sensors to a multi-core cable in an enclosure directly adjacent to the electrical distribution unit. The multi-core cable between the enclosure and F370 must have a cable area of at least 0.5 mm<sup>2</sup>.

Connect the cable to the input board (AA3) on terminal X4:1-4 block - where X4:1 is the common terminal block for the three current sensors.

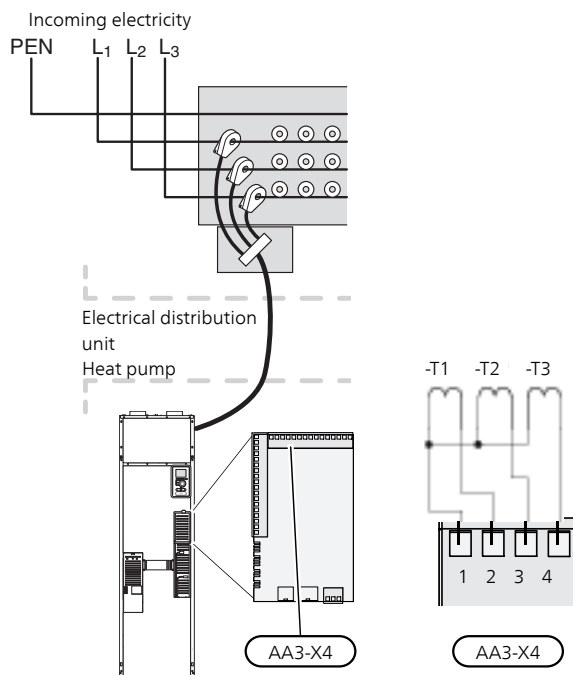

## NIBE Uplink

Connect the network connected cable (straight, Cat.5e UTP) with RJ45-contact (male) to RJ45 contact (female) on the rear of the heat pump.



## External connection options

F370 has software controlled inputs and outputs on the input card (AA3), for connecting the external switch function or sensor. This means that when an external switch function or sensor is connected to one of six special connections, the correct function must be selected to the correct connection in the software in F370.



### Caution

If an external switch function or sensor is connected to F370, the function to use input or output must be selected in menu 5.4, see page 47.

Selectable inputs on the input card for these functions are AUX1 (X6:9-10), AUX2 (X6:11-12), AUX3 (X6:13-14), AUX4 (X6:15-16) and AUX5 (X6:17-18). Selectable outputs are AA3:X7.

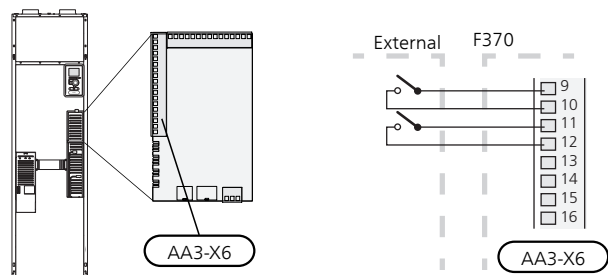
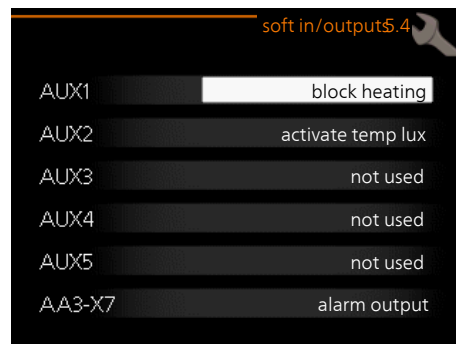

The example above uses the inputs AUX1 (X6:9-10) and AUX2 (X6:11-12) on the input circuit board (AA3).

**Caution**

Some of the following functions can also be activated and scheduled via menu settings.

**Possible selection for AUX inputs****Switch for external blocking of addition and/or compressor**

Blocking for addition heat and compressor is connected on two different AUX inputs.

If external blocking of additional heat and/or compressor is wanted, this can be connected to terminal block X6 on the input board (AA3), which is positioned behind the front cover.

The additional heat and/or the compressor are disconnected by connecting a potential-free switch function to the input selected in menu 5.4, see page 47.

External blocking of addition and compressor can be combined.

A closed contact results in the electrical output being disconnected.

**Contact for external tariff blocking**

In those cases where external tariff blocking is used, it can be connected to terminal block X6 on the input board (AA3), which is positioned behind the front cover.

Tariff blocking means that the additional heat, the compressor, the heating and hot water are blocked by connecting a potential-free switch function to the input selected in menu 5.4, see page 47.

Closed switch means that tariff blocking is activated.

**NOTE**

When tariff blocking is activated, the min. supply line does not apply.

**Switch for "SG ready"****NOTE**

This function can only be used in mains networks that support the "SG Ready"-standard. "SG Ready" requires two AUX inputs.

In cases where this function is required, it must be connected to terminal block X6 on the input card (AA3).

"SG Ready" is a smart form of tariff control where your electricity supplier can affect the indoor and hot water temperatures or simply block the additional heat and/or the compressor in the heat pump at certain times of the day (can be selected in menu 4.1.5 after the function is activated). Activate the function by connecting potential-free switch functions to two inputs selected in menu 5.4 (SG Ready A and SG Ready B), see page 47.

Closed or open switch means one of the following:

- **Blocking (A: Closed, B: Open)**

"SG Ready" is active. The compressor in the heat pump and additional heat is blocked like the day's tariff blocking.

- **Normal mode (A: Open, B: Open)**

"SG Ready" is not active. No effect on the system.

- **Low price mode (A: Open, B: Closed)**

"SG Ready" is active. The system focuses on costs savings and can for example exploit a low tariff from the electricity supplier or over-capacity from any own power source (effect on the system can be adjusted in the menu 4.1.5).

- **Overcapacity mode (A: Closed, B: Closed)**

"SG Ready" is active. The system is permitted to run at full capacity at over capacity (very low price) with the electricity supplier (effect on the system is settable in menu 4.1.5).

(A = SG Ready A and B = SG Ready B)

**Switch for +Adjust**

Using +Adjust, the installation communicates with the underfloor heating's control centre\* and adjusts the heat curve and calculated supply temperature according to the underfloor heating system's reconnection.

Activate the climate system you want +Adjust to affect by highlighting the function and pressing the OK button.

\*Support for +Adjust required

**NOTE**

+Adjust must first be selected in menu 5.4 "soft inputs/outputs".

**NOTE**

Circuit board AA3 in the installation must have at least "Input version" 34 and the software version must have "display version 5539 or later for +Adjust to work. The version can be checked in menu 3.1 under "input version" respectively "display version". New software can be downloaded for free from [www.nibeuplink.com](http://www.nibeuplink.com).

**NOTE**

In systems with both under floor heating and radiators, NIBE ECS 40/41 should be used for optimum operation.

**Switch for external blocking of heating**

In those cases where external blocking of heat is used, it can be connected to terminal block X6 on the input board (AA3), which is positioned behind the front cover.

Heating operation is disconnected by connecting a potential-free switch function to the input selected in menu 5.4, see page 47.

A closed switch results in blocked heating operation.

**NOTE**

When heat blocking is activated, the min. supply line does not apply.

### Switch for external blocking of hot water

In cases where external blocking of hot water is used, this can be connected to terminal block X6 on the input board (AA3), which is positioned behind the front cover.

Hot water operation is disconnected by connecting a potential-free switch function to the input selected in menu 5.4, see page 47.

A closed switch results in blocked hot water operation.

### Contact for activation of "temporary lux"

An external switch function can be connected to F370 for activation of the hot water function "temporary lux". The switch must be potential-free and connected to the selected input (menu 5.4, see page 47) on terminal block X6 on the input board (AA3).

"temporary lux" is activated for the time that the contact is connected.

### Contact for activation of "external adjustment"

An external contact function can be connected to F370 to change the supply temperature and the room temperature.

When the switch is closed the temperature changes in °C (if the room sensor is connected and activated). If a room sensor is not connected or activated, the desired change of "temperature" (heating curve offset) with the number of steps selected is set. The value is adjustable between -10 and +10.

#### ■ climate system 1

The switch must be potential-free and connected to the selected input (menu 5.4, see page 47) on terminal block X6 on the input board (AA3).

The value for the change is set in menu 1.9.2, "external adjustment".

#### ■ climate system 2 to 8

External adjustment for climate systems 2 to 8 requires accessories (ECS 40 or ECS 41).

See the accessory's installer handbook for installation instructions.

### Contact for activation of fan speed

An external contact function can be connected to F370 for activation of one of the four fan speeds. The switch must be potential free and connected to the selected input (menu 5.4, see page 47) on terminal block X6 on the input circuit board (AA3). When the switch closes, the selected fan speed is activated. Normal speed is resumed when the contact is opened again.

### Possible selection for AUX output (potential free variable relay)

It is possible to have an external connection through the relay function via a potential-free variable relay (max 2 A) on the input circuit board (AA3), terminal block X7.

Optional functions for external connection:

- Indication of buzzer alarm.
- Control of circulation pump for hot water circulation.
- External circulation pump, for example external pump and shunt group.

If any of the above is installed to terminal block X7 it must be selected in menu 5.4, see page 47.

The common alarm is preselected at the factory.



#### NOTE

An accessory board is required, if several functions are connected to terminal block X7 at the same time the common alarm is activated (see page 55).

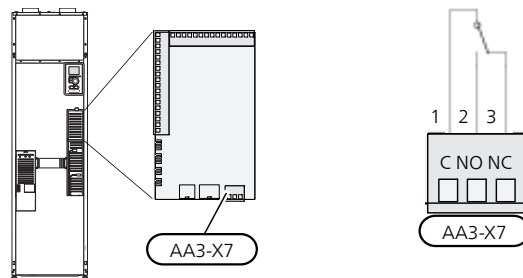

The picture shows the relay in the alarm position.

When switch (SF1) is in the "U" or "Δ" position the relay is in the alarm position.

External circulation pump or hot water circulation pump connected to the buzzer alarm relay as illustrated below.



#### NOTE

Mark up any junction boxes with warnings for external voltage.

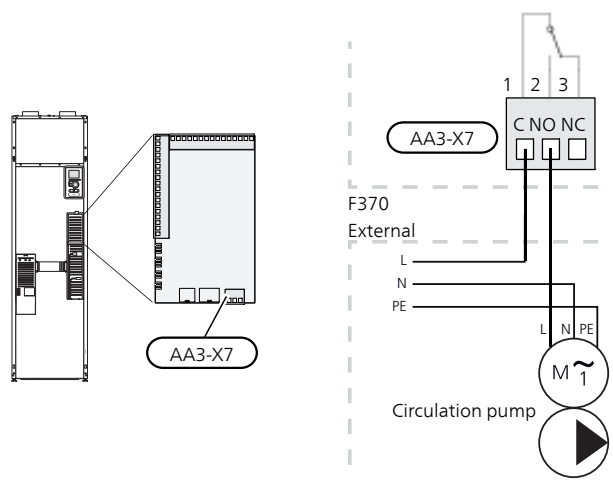

## Connecting accessories

Instructions for connecting accessories are provided in the manual accompanying the accessory. See page 55 for the list of the accessories that can be used with F370.

# 6 Commissioning and adjusting

## Preparations

1. Check that the switch (SF1) is in position "⏻".
2. Check that the filling valves (QM10) and (QM11) are fully closed.



### Caution

Check the miniature circuit-breaker (FA1) in the heat pump. It may have tripped during transportation.

## Filling and venting

### Filling the hot water heater

1. Open a hot water tap in the house.
2. Open the filling valve (QM10). This valve should then be fully open during operations.
3. When water comes out of the hot water tap, the hot water heater is full and the tap can be closed.

### Filling the climate system

1. Check that the shut-off valves for the heating system (QM31) and (QM32) are open.
2. Open the vent valve (QM20).
3. Open the filler valves (QM11) and (QM13). The heating section and the rest of the climate system are filled with water.
4. When the water exiting the vent valve (QM20) is no longer mixed with air, close the valve. After a while, the pressure rises on the pressure gauge (BP5). When the pressure reaches 2.5 bar (0.25 MPa), the safety valve (FL2) starts to release water. Close the filler valve (QM11).
5. Reduce the boiler pressure to the normal working range (approx. 1 bar) by opening the vent valve (QM20) or the safety valve (FL2).
6. Check that there is water in the overflow cup (WM1).

If the overflow cup requires topping up:

1. Turn the safety valve for hot water (FL1) anticlockwise carefully.

### Venting the climate system

1. Turn off the power supply to the heat pump.
2. Vent the heat pump via the vent valve (QM20) and the rest of the climate system via the relevant vent valves.
3. Keep topping up and venting until all air has been removed and the pressure is correct.



### NOTE

The vent pipe from the container must be drained of water before air can be released. This means that the system is not necessarily bled despite the flow of water when the bleed valve (QM20) is opened.

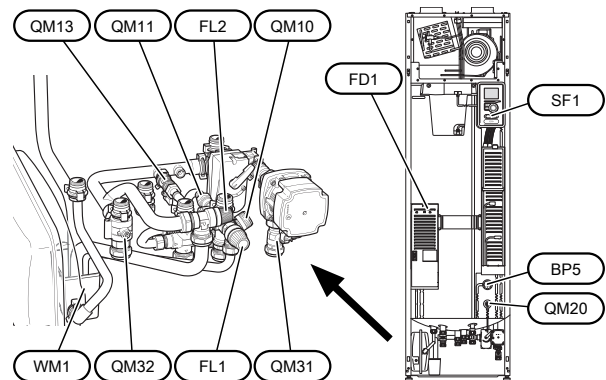



# Start-up and inspection

## Start guide



### NOTE

There must be water in the climate system before the switch is set to "I".

1. Set switch (SF1) on F370 to position "I".
2. Follow the instructions in the display's start guide. If the start guide does not start when you start the F370, start it manually in menu 5.7.



### TIP

See page 38 for a more in-depth introduction to the heat pump's control system (operation, menus etc.).

## Commissioning

The first time the heat pump is started a start guide is started. The start guide instructions state what needs to be carried out at the first start together with a run through of the heat pump's basic settings.

The start guide ensures that start-up is carried out correctly and cannot be bypassed. The start guide can be started later in menu 5.7.



### Caution

As long as the start guide is active, no function in the installation will start automatically.

The guide will appear at each installation restart until it is deselected on the last page.

## Operation in the start guide

A. Page

B. Name and menu number

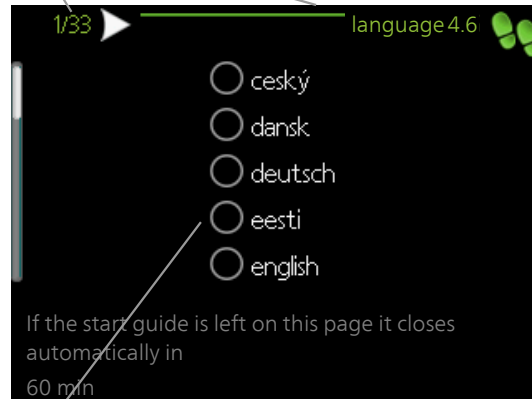

C. Option / setting

### A. Page

Here you can see how far you have come in the start guide.

Scroll between the pages of the start guide as follows:

1. Turn the control knob until one of the arrows in the top left corner (at the page number) has been marked.
2. Press the OK button to skip between the pages in the start guide.

### B. Name and menu number

Read what menu in the control system this page of the start guide is based on. The digits in brackets refer to the menu number in the control system.

If you want to read more about affected menus either consult the help menu or read the user manual.

### C. Option / setting

Make settings for the system here.

### D. Help menu



In many menus there is a symbol that indicates that extra help is available.

To access the help text:

1. Use the control knob to select the help symbol.
2. Press the OK button.

The help text often consists of several windows that you can scroll between using the control knob.

## Setting the ventilation

Ventilation must be set according to applicable standards. Set the fan speed in menu 5.1.5.

Even if ventilation is roughly set at installation it is important that a ventilation adjustment is ordered and permitted.



### NOTE

Order a ventilation adjustment to complete the setting.

### Ventilation capacity

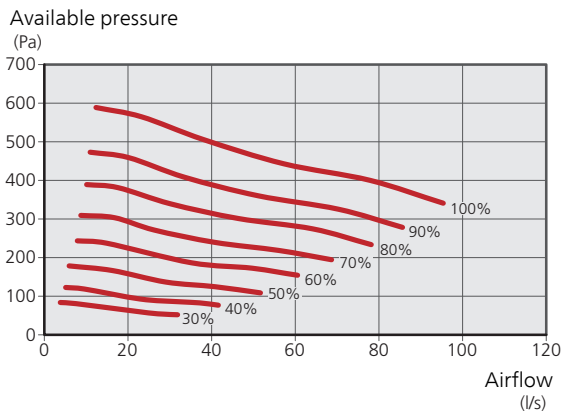

### Fan rating

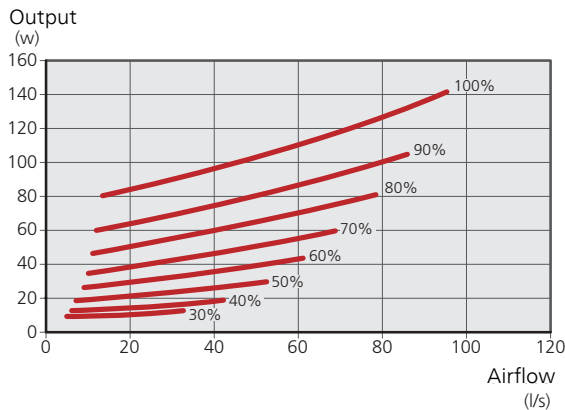

## Commissioning without fan

The heat pump can be run without recovery, as only an electric boiler, to produce heat and hot water, for example before the ventilation installation is complete.

Enter menu 4.2 - "op. mode" and select "add. heat only"

Enter menu 5.1.5 - "fan sp. exhaust air" and reduce the fan speed to 0%.



### NOTE

Select operating mode "auto" or "manual" when the heat pump is to run on recovery again.

## Setting circulation pump

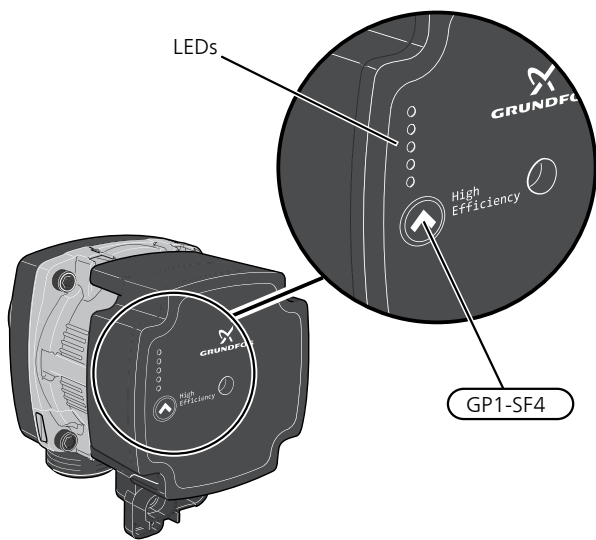

The circulation pump (GP1) is equipped with five LEDs. In normal mode, the LEDs show the power consumption. They can also indicate alarms or be used to display the pump speed.

During normal operation, the LED lights 1 green. The other LEDs light yellow and indicate the pump's power consumption according to the following table.

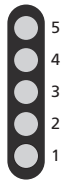

LED indication	Power consumption (% of max power consumption)
Green LED (flashing)	0
Green + one yellow LED	0 – 25
Green + two yellow LEDs	25 – 50
Green + three yellow LEDs	50 – 75
Green + four yellow LEDs	75 – 100

The speed of the circulation pump (GP1) is set using the switch (GP1-SF4) so that the projected flow for the house is achieved. To change the speed, press and hold the switch until the LEDs start to flash. Scroll between the various speeds by pressing the switch.

Choose between 10 different speeds on the pump. There are three different control curves for proportional pressure (PP), or three different constant pressure (CP) and four constant curves (CC).

Press the switch once to see what speed is selected.

To lock/unlock a setting, press and hold the button for 10 seconds.

## Pump speed, proportional pressure (PP)

Capacity, circulation pump (PP)

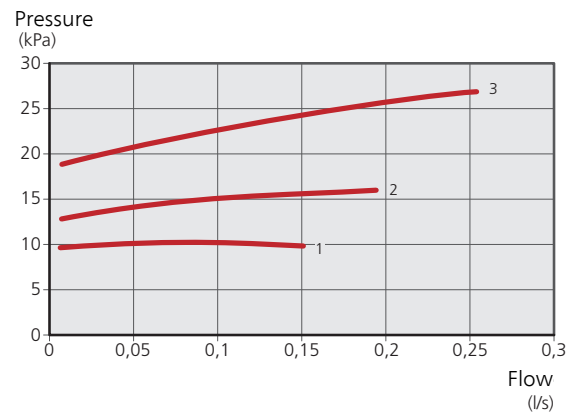

Output, circulation pump (PP)

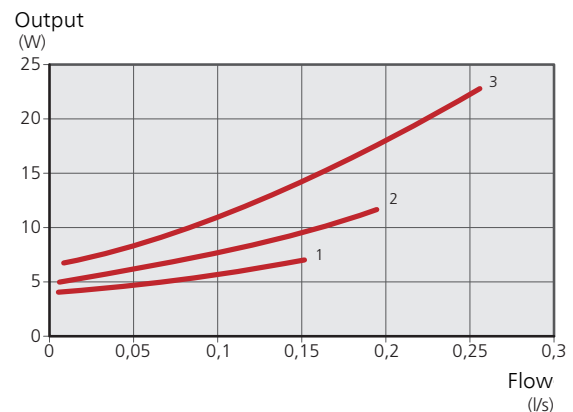

Pump speed (PP)	1	2	3
LED indication			

### Pump speed, constant pressure (CP)

Capacity, circulation pump (CP)

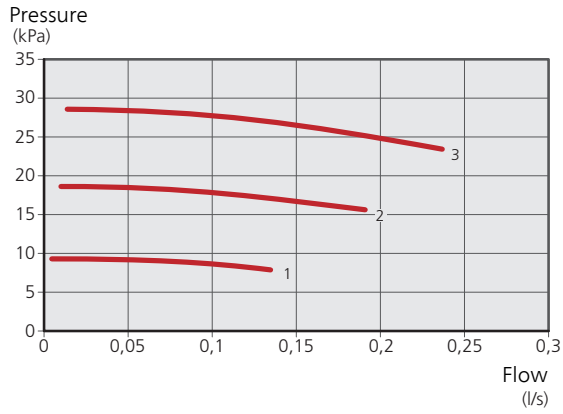

### Pump speed, constant curve (CC)

Capacity, circulation pump (CC)

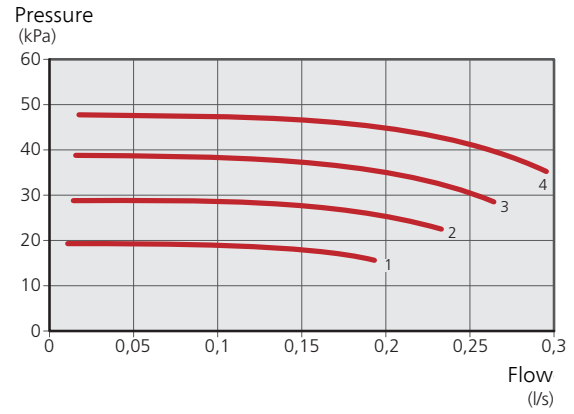

Output, circulation pump (CP)

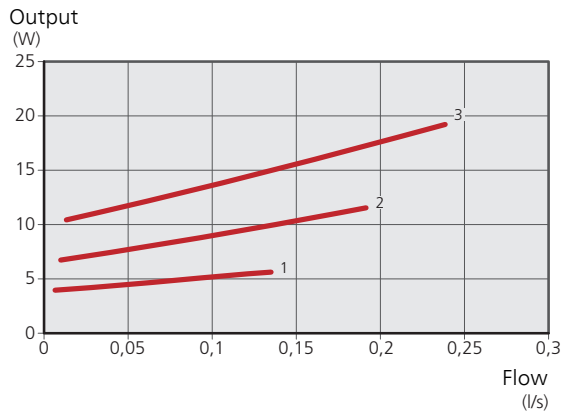

Output, circulation pump (CC)

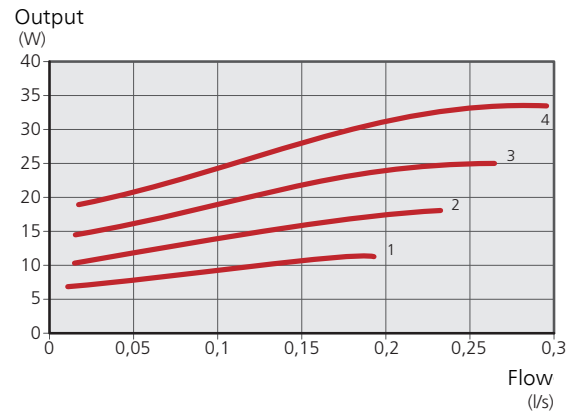

Pump speed (CP)	1	2	3*
LED indication			

Pump speed (CC)	1	2	3	4
LED indication				

\*The pump is factory-set with constant pressure (CP) speed 3

## Alarm

In the event of an alarm the LED changes 1 colour from green to red. When one or several alarms are active, this is indicated according to the following table. If more than one alarm is active, the one with the highest priority is displayed.

LED indication	Cause / Action
Red + yellow LED (LED 5)	The rotor is blocked. Wait or release the rotor shaft.
Red + yellow LED (LED 4)	Supply voltage too low. Check the supply voltage.
Red + yellow LED (LED 3)	Electrical fault. Check the supply voltage or replace the circulation pump.

## Post-adjustment, venting

Air is initially released from the hot water and venting may be necessary. If gurgling sounds can be heard from the heat pump or climate system, the entire system requires additional venting. See section "Venting the climate system" on page 32 for information about venting the heat pump.

# 7 Control - Introduction

## Display unit

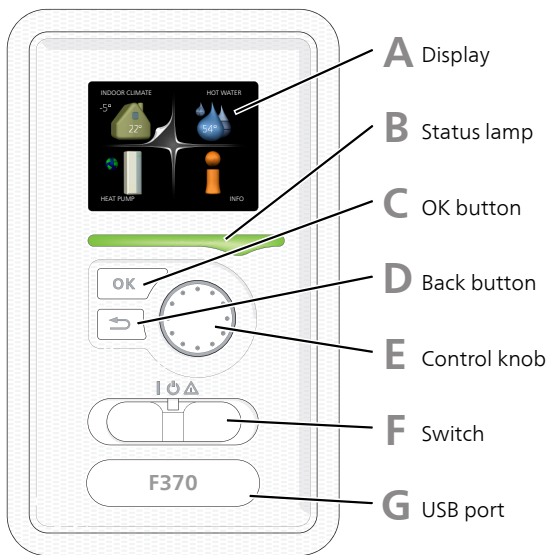

### A Display

Instructions, settings and operational information are shown on the display. You can easily navigate between the different menus and options to set the comfort or obtain the information you require.

### B Status lamp

The status lamp indicates the status of the heat pump. It:

- lights green during normal operation.
- lights yellow in emergency mode.
- lights red in the event of a deployed alarm.

### C OK button

The OK button is used to:

- confirm selections of sub menus/options/set values/page in the start guide.

### D Back button

The back button is used to:

- go back to the previous menu.
- change a setting that has not been confirmed.

### E Control knob

The control knob can be turned to the right or left. You can:

- scroll in menus and between options.
- increase and decrease the values.
- change page in multiple page instructions (for example help text and service info).

### F Switch (SF1)

The switch assumes three positions:

- On (I)
- Standby (⏻)
- Emergency mode (⚠) (see page 49)

Emergency mode must only be used in the event of a fault on the heat pump. In this mode, the compressor switches off and the immersion heater engages. The heat pump display is not illuminated and the status lamp illuminates yellow.

### G USB port

The USB port is hidden beneath the plastic badge with the product name on it.

The USB port is used to update the software.

Visit [www.nibeuplink.com](http://www.nibeuplink.com) and click the "Software" tab to download the latest software for your installation.

## Menu system

When the door to the heat pump is opened, the menu system's four main menus are shown in the display as well as certain basic information.

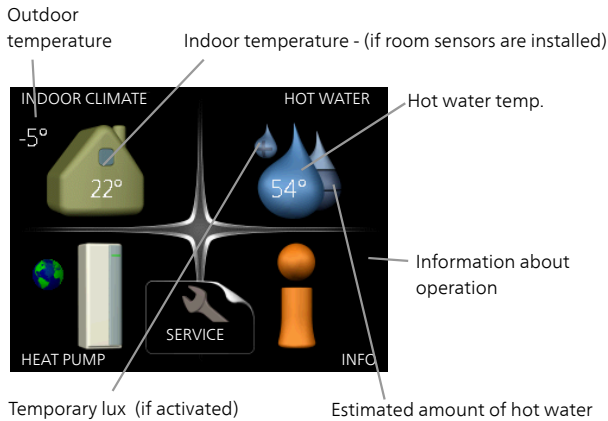

### Menu 1 - INDOOR CLIMATE

Setting and scheduling the indoor climate. See information in the help menu or user manual.

### Menu 2 - HOT WATER

Setting and scheduling hot water production. See information in the help menu or user manual.

### Menu 3 - INFO

Display of temperature and other operating information and access to the alarm log. See information in the help menu or user manual.

### Menu 4 - HEAT PUMP

Setting time, date, language, display, operating mode etc. See information in the help menu or user manual.

### Menu 5 - SERVICE

Advanced settings. These settings are not available to the end user. The menu is visible when the Back button is pressed for 7 seconds when you are in the start menu. See page 44.

## Symbols in the display

The following symbols can appear in the display during operation.

Symbol	Description
	This symbol appears by the information sign if there is information in menu 3.1 that you should note.
	These two symbols indicate whether the compressor or addition is blocked in F370. These can, for example, be blocked depending on which operating mode is selected in menu 4.2, if blocking is scheduled in menu 4.9.5 or if an alarm has occurred that blocks one of them. Blocking the compressor. Blocking additional heat.
	This symbol appears if periodic increase or lux mode for the hot water is activated.
	This symbol indicates whether "holiday setting" is active in 4.7.
	This symbol indicates whether F370 has contact with NIBE Uplink.
	This symbol indicates the actual speed of the fan if the speed has changed from the normal setting.
	This symbol indicates whether solar heating is active. Accessory needed.

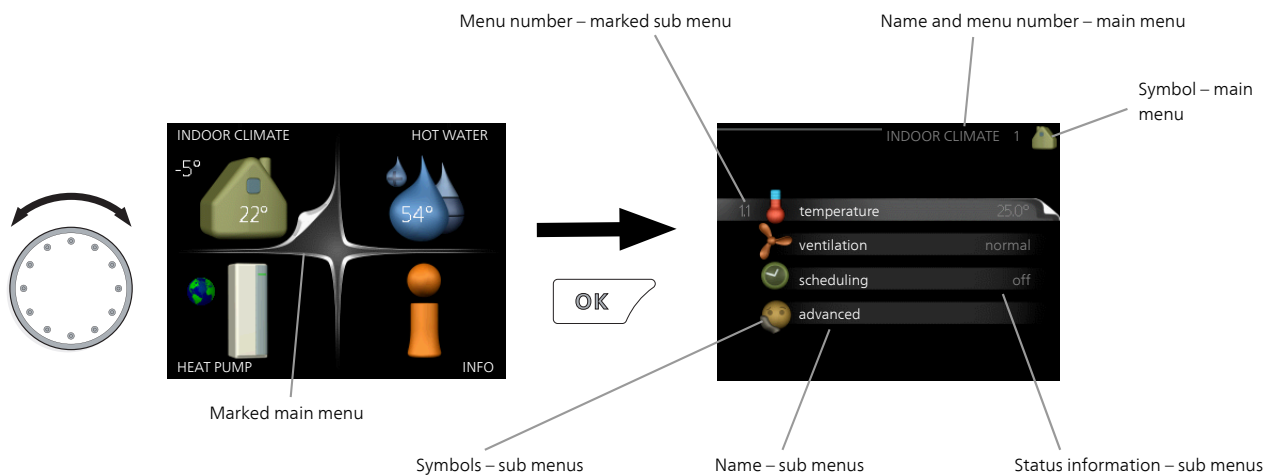

## Operation

To move the cursor, turn the control knob to the left or the right. The marked position is white and/or has a turned up tab.



## Selecting menu

To advance in the menu system select a main menu by marking it and then pressing the OK button. A new window then opens with sub menus.

Select one of the sub menus by marking it and then pressing the OK button.

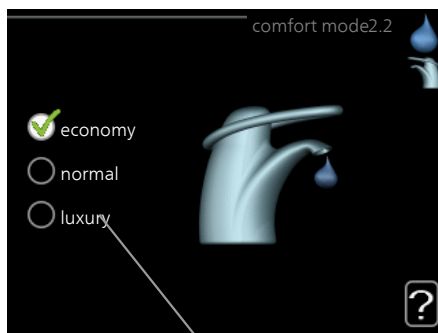

## Selecting options



Alternative

In an options menu the current selected option is indicated by a green tick. 

To select another option:



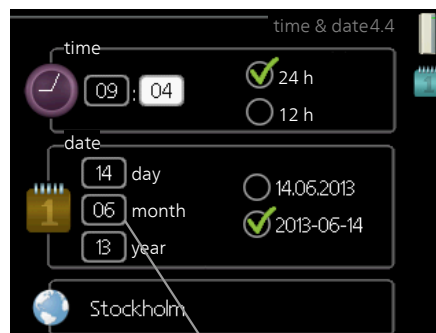

1. Mark the applicable option. One of the options is pre-selected (white). 
2. Press the OK button to confirm the selected option. The selected option has a green tick. 

## Setting a value



Values to be changed

To set a value:

1. Mark the value you want to set using the control knob. 
2. Press the OK button. The background of the value becomes green, which means that you have accessed the setting mode. 
3. Turn the control knob to the right to increase the value and to the left to reduce the value. 
4. Press the OK button to confirm the value you have set. To change and return to the original value, press the Back button. 



## Use the virtual keyboard

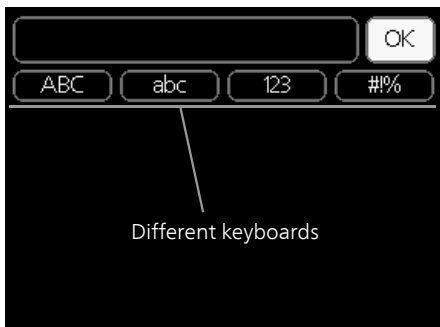

In some menus where text may require entering, a virtual keyboard is available.

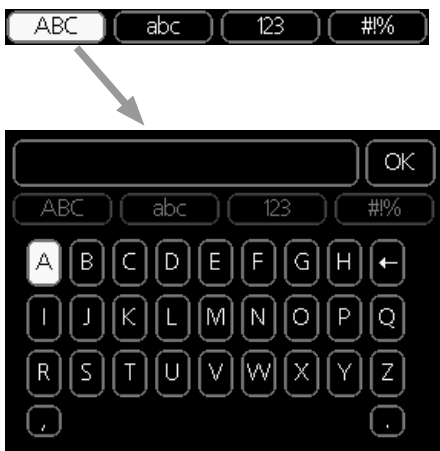

Depending on the menu, you can gain access to different character sets which you can select using the control knob. To change character table, press the Back button. If a menu only has one character set the keyboard is displayed directly.

When you have finished writing, mark "OK" and press the OK button.

## Scroll through the windows

A menu can consist of several windows. Turn the control knob to scroll between the windows.



Current menu window      Number of windows in the menu

## Scroll through the windows in the start guide



Arrows to scroll through window in start guide

1. Turn the control knob until one of the arrows in the top left corner (at the page number) has been marked.
2. Press the OK button to skip between the steps in the start guide.

## Help menu



In many menus there is a symbol that indicates that extra help is available.

To access the help text:

1. Use the control knob to select the help symbol.
2. Press the OK button.

The help text often consists of several windows that you can scroll between using the control knob.

# 8 Control - Menus

## Menu 1 - INDOOR CLIMATE

### Overview

1 - INDOOR CLIMATE	1.1 - temperature	
	1.2 - ventilation	
	1.3 - scheduling	1.3.1 - heating
		1.3.3 - ventilation
	1.9 - advanced	1.9.1.1 - heating curve
		1.9.2 - external adjustment
		1.9.3 - min. flow line temp.
		1.9.4 - room sensor settings
		1.9.6 - fan return time
		1.9.7 - own curve
	1.9.8 - point offset	
	1.9.9 - night cooling	

## Menu 2 - HOT WATER

### Overview

2 - HOT WATER	2.1 - temporary lux	
	2.2 - comfort mode	
	2.3 - scheduling	
	2.9 - advanced	2.9.1 - periodic increase
		2.9.2 - hot water recirc. *

\* Accessory needed.

## Menu 3 - INFO

### Overview

3 - INFO	3.1 - service info
	3.2 - compressor info
	3.3 - add. heat info
	3.4 - alarm log
	3.5 - indoor temp. log

## Menu 4 - HEAT PUMP

### Overview

4 - HEAT PUMP	4.1 - plus functions *	4.1.3 - internet	4.1.3.1 - NIBE Uplink
			4.1.3.8 - tcp/ip settings
			4.1.3.9 - proxy settings
		4.1.4 - sms *	
		4.1.5 - SG Ready	
		4.1.6 - smart price adaption™	
		4.1.7 - smart home	
	4.2 - op. mode		
	4.3 - my icons		
	4.4 - time & date		
	4.6 - language		
	4.7 - holiday setting		
	4.9 - advanced	4.9.2 - auto mode setting	
		4.9.4 - factory setting user	
		4.9.5 - schedule blocking	

\* Accessory needed.

## Menu 5 - SERVICE

### Overview

5 - SERVICE	5.1 - operating settings	5.1.1 - hot water settings
		5.1.2 - max flow line temperature
		5.1.4 - alarm actions
		5.1.5 - fan sp. exhaust air
		5.1.12 - internal electrical addition
		5.1.13 - max inst. el.pwr (BBR)
		5.1.99 - other settings
	5.2 - system settings	5.2.4 - accessories
	5.3 - accessory settings	5.3.3 - extra climate system *
	5.4 - soft in/outputs	
	5.5 - factory setting service	
	5.6 - forced control	
	5.7 - start guide	
	5.8 - quick start	
	5.9 - floor drying function	
	5.10 - change log	
	5.12 - country	

\* Accessory needed.

Go to the main menu and hold the Back button in for 7 seconds to access the Service menu.

### Sub-menus

Menu **SERVICE** has orange text and is intended for the advanced user. This menu has several sub-menus. Status information for the relevant menu can be found on the display to the right of the menus.

**operating settings** Operating settings for the heat pump.

**system settings** System settings for the heat pump, activating accessories etc.

**accessory settings** Operational settings for different accessories.

**soft in/outputs** Setting software controlled in and outputs on the input circuit board (AA3).

**factory setting service** Total reset of all settings (including settings available to the user) to default values.

**forced control** Forced control of the different components in the heat pump.

**start guide** Manual start of the start guide which is run the first time the heat pump is started.

**quick start** Quick starting the compressor.



#### NOTE

Incorrect settings in the service menus can damage the heat pump.

### Menu 5.1 - operating settings

Operating settings can be made for the heat pump in the sub menus.

## Menu 5.1.1 - hot water settings

### **economy**

Setting range start temp. economy: 15 - 52 °C

Factory setting start temp. economy: 45 °C

F370 copper: 43 °C

F370 stainless steel: 42 °C

Setting range stop temp. economy: 15 - 55 °C

Factory setting stop temp. economy: 51 °C

F370 copper: 47 °C

F370 stainless steel: 46 °C

### **normal**

Setting range start temp. normal: 15 - 52 °C

Factory setting start temp. normal: 49 °C

F370 copper: 47 °C

F370 stainless steel: 46 °C

Setting range stop temp. normal: 15 - 55 °C

Factory setting stop temp. normal: 55 °C

F370 copper: 51 °C

F370 stainless steel: 50 °C

### **luxury**

Setting range start temp. lux: 15 - 62 °C

Factory setting start temp. lux: 52 °C

F370 copper: 50 °C

F370 stainless steel: 49 °C

Setting range stop temp. lux: 15 - 65 °C

Factory setting stop temp. lux: 58 °C

F370 copper: 54 °C

F370 stainless steel: 53 °C

### **stop temp. per. increase**

Setting range: 55 – 70 °C

Factory setting: 60 °C

Here you set the start and stop temperature of the hot water for the different comfort options in menu 2.2 as well as the stop temperature for periodic increase in menu 2.9.1.

## Menu 5.1.2 - max flow line temperature

### **climate system**

Setting range: 20-70 °C

Default value: 60 °C

Set the maximum supply temperature for the climate system here. If the installation has more than one climate system, individual maximum supply temperatures can be set for each system. Climate systems 2 - 8 cannot be set to a higher max supply temperature than climate system 1.



#### **Caution**

Underfloor heating systems are normally **max flow line temperature** set between 35 and 45 °C.

Check the max floor temperature with your floor supplier.

## Menu 5.1.4 - alarm actions

Select if you want the heat pump to alert you that there is an alarm in the display here.



#### **Caution**

If no alarm action is selected, it can result in higher energy consumption in the event of an alarm.

## Menu 5.1.5 - fan sp. exhaust air

### **normal and speed 1-4**

Setting range: 0 – 100 %

Set the speed for the five different selectable speeds for the fan here.



#### **Caution**

An incorrectly set ventilation flow can damage the house and may also increase energy consumption.

## Menu 5.1.12 - internal electrical addition

### **set max electrical add.**

Setting range 3x400 V: 0 - 10.25 kW

Setting range 3x230 V: 0 - 12 kW

Default values: 5.3 kW

### **fuse size**

Setting range: 1 - 200 A

Factory setting: 16 A

### **transformation ratio**

Setting range: 300 - 3000

Factory setting: 300

Here you set the max. electrical output of the internal electric additional heat in F370 during normal operation and overcapacity mode (SG Ready), as well as the fuse size and transformer ratio for the installation. The transformer ratio is the factor that is used to convert the metered voltage to current.

Here you can also check which current sensor is installed on which incoming phase to the property (this requires current sensors to be installed, see page 28). Check by marking "detect phase order" and pressing the OK button.

The results of these checks appear just below the menu selection "detect phase order".

## Menu 5.1.13 - max inst. el.pwr (BBR)

### **max installed el.pwr (only this machine)**

Setting range: 0.000 - 30.000 kW

Default values: 15.000 kW

If the above building regulations are not applicable, do not use this setting.

In order to meet certain building regulations, it is possible to lock the device's maximum power output. In this menu, you can set the value corresponding to the heat pump's maximum power connection for heating, hot water and cooling, if applicable. Note whether there are also external electrical components that are to be included. After the value has been locked, a weeks cooling-off period starts. After this period, parts in the machine must be replaced in order to obtain greater power.

## Menu 5.1.99 - other settings

### **trend calculation limit**

Setting range: 0 – 20 °C

Default value: 7 °C

### **transfer time**

Setting range: 1 - 60 min

Default value: 15 min

### **months btwn filter alarms**

Setting range: 1 – 12

Default value: 3

Here you can set trend calculation limit, transfer time, months btwn filter alarms and fan synch. operation .

### **trend calculation limit**

Here you set at what outdoor temperature the trend calculation is to be active. Above this limit, connection of the immersion heater is delayed and the immersion heater is not connected if the compressor is able to increase the temperature in the vessel.

### **transfer time**

Here you can set transfer time between heating and hot water production in F370. During the transfer time the compressor maintains the stop temperature that applied during hot water production.

### **months btwn filter alarms**

Here you set the number of months between alarms for a reminder to clean the filter in F370.

### **fan synch. operation**

Select whether the fan is to maintain the same speed, regardless of whether the compressor is operating or not, or alternatively run at different speeds. If the function is activated, fan speed 2 applies when the compressor is not in operation, and normal fan speed applies when the compressor is in operation.

## Menu 5.2 - system settings

Make different system settings for the heat pump here, e.g. which accessories are installed.

### Menu 5.2.4 - accessories

Inform the heat pump which accessories are installed here.

There are two ways of activating connected accessories. You can either mark the alternative in the list or use the automatic function "search installed acc."

### **search installed acc.**

Mark "search installed acc." and press the OK button to automatically find connected accessories for F370.

## Menu 5.3 - accessory settings

The operating settings for accessories that are installed and activated are made in the sub-menus for this.

### Menu 5.3.3 - extra climate system

#### *mixing valve amplifier*

Setting range: 0.1 – 10.0

Default value: 1.0

#### *mixing valve step delay*

Setting range: 10 – 300 s

Default values: 30 s



#### Caution

This setting option only appears if "passive/active cooling 2-pipe" or "passive cooling 2-pipe" is activated in menu 5.2.4.

The shunt amplification and shunt waiting time for the different extra climate systems that are installed are also set here.

See the accessory installation instructions for function description.

## Menu 5.4 - soft in/outputs

Here you can select the in/output on the input circuit board (AA3) the external contact function (page 28) is to be connected to.

Selectable inputs on terminal block AUX1-5 (AA3-X6:9-18) and output AA3-X7 (on the input circuit board).

## Menu 5.5 - factory setting service

All settings can be reset (including settings available to the user) to default values here.



#### NOTE

When resetting, the start guide is displayed the next time the heat pump is restarted.

## Menu 5.6 - forced control

You can force control the different components in the heat pump and any connected accessories here.

## Menu 5.7 - start guide

When the heat pump is started for the first time the start guide starts automatically. Start it manually here.

See page 33 for more information about the start guide.

## Menu 5.8 - quick start

It is possible to start the compressor from here.



#### Caution

There must be a heating or hot water demand to start the compressor.



#### Caution

Do not quick start the compressor too many times over a short period of time as this may damage the compressor and its surrounding equipment.

## Menu 5.9 - floor drying function

### *length of period 1 – 7*

Setting range: 0 – 30 days

Factory setting, period 1 – 3, 5 – 7: 2 days

Factory setting, period 4: 3 days

### *temp. period 1 – 7*

Setting range: 15 – 70 °C

Default value:

temp. period 1	20 °C
temp. period 2	30 °C
temp. period 3	40 °C
temp. period 4	45 °C
temp. period 5	40 °C
temp. period 6	30 °C
temp. period 7	20 °C

Set the function for under floor drying here.

You can set up to seven period times with different calculated flow temperatures. If less than seven periods are to be used, set the remaining period times to 0 days.

Mark the active window to activate the underfloor drying function. A counter at the bottom shows the number of days the function has been active.



#### TIP

If operating mode "add. heat only" is to be used, select it in menu 4.2.

## Menu 5.10 - change log

Read off any previous changes to the control system here.

The date, time and ID no. (unique to certain settings) and the new set value is shown for every change.



#### NOTE

The change log is saved at restart and remains unchanged after factory setting.

## 5.12 - country

Select here where the product was installed. This allows access to country specific settings in your product.

Language settings can be made regardless of this selection.



### NOTE

This option locks after 24 hours, restart of display or program updating.



# 9 Service



## NOTE

Servicing and maintenance should only be carried out by persons with the necessary expertise.

When replacing components on F370 only replacement parts from NIBE may be used.

## Maintenance

Inform the user of necessary maintenance action.

### Cleaning the overflow cup/floor drain

Regularly check that the overflow cup and any floor drains are not blocked; water must be able to run through freely. Clean, if necessary.



## NOTE

If the overflow cup or floor drain is blocked, water can run over onto the floor of the installation area. To prevent damage to the building the floor coating must be considered. A waterproof floor or floor membrane is recommended.

## Service actions

### Emergency mode

Emergency mode is used in event of operational interference and in conjunction with service.

Emergency mode is activated by setting switch (SF1) in mode "Δ". This means that:

- The status lamp illuminates yellow.
- The display is not lit and the control computer is not connected.
- The temperature in the heating section is controlled by a fixed thermostat (BT30) at 63°C.
- The compressor is off and only the fan, heating medium pump and the electric additional heat are active. The additional heat power in emergency mode is set in the immersion heater card (AA1). See page 26 for instructions.
- The automatic heating control system is not operational, so manual shunt operation is required. This is done by turning the adjustment screw on the shunt motor (MA1) to "manual mode" and then turning the shunt lever to the desired position.

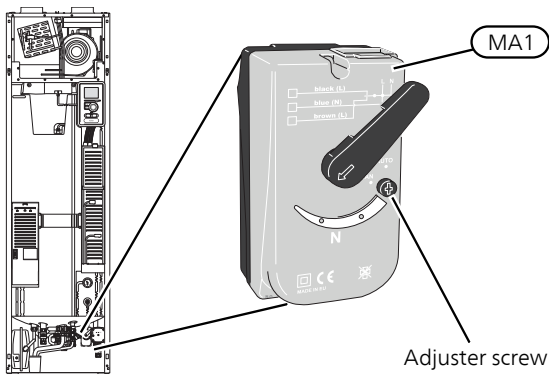

### Draining the water heater

The water heater can be drained via the safety valve (FL1) or via the overflow cup (WM1).

1. Disconnect the overflow pipe from the safety valve (FL1) and connect a hose to a draining pump instead. If a draining pump is not available, the water can be released into the overflow cup (WM1).
2. Open the safety valve (FL1).
3. Open a hot water tap to let air into the system. If this is not sufficient, detach the pipe connection (XL4) on the hot water side and ensure that air is entering.

### Draining the climate system

In order to carry out service on the climate system, it may be easier to drain the system first.



## NOTE

There may be some hot water when draining the heating medium side/climate system. There is a risk of scalding.

The hot water can be drained through the safety valve (FL2) via the overflow cup (WM1) or through a hose that is connected to the safety valve's (FL2) outlet.

1. Open the safety valve (FL2).
2. Set the vent valve for the climate system (QM20) in the open position for air supply.

## Helping the circulation pump to start

The circulation pump in F370 has an automatic start help function. If necessary the pump can be started manually. In such cases, take the following action:

1. Shut off F370 by setting the switch (SF1) to mode "0".
2. Remove the front hatch.
3. Press the screw for start help in using a star head screwdriver as illustrated.
4. With the screw pressed in, turn the screwdriver in any direction.
5. Start F370 by setting the switch (SF1) to mode "I" and check that the circulation pump functions.

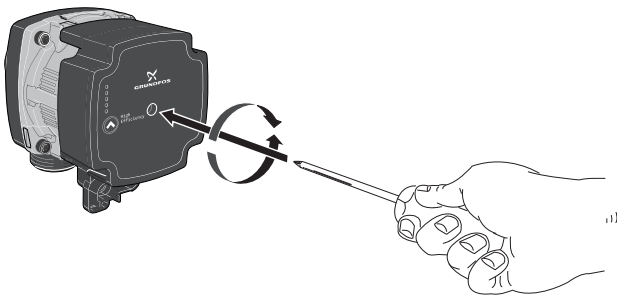

## Temperature sensor data

Temperature (°C)	Resistance (kOhm)	Voltage (VDC)
-40	351.0	3.256
-35	251.6	3.240
-30	182.5	3.218
-25	133.8	3.189
-20	99.22	3.150
-15	74.32	3.105
-10	56.20	3.047
-5	42.89	2.976
0	33.02	2.889
5	25.61	2.789
10	20.02	2.673
15	15.77	2.541
20	12.51	2.399
25	10.00	2.245
30	8.045	2.083
35	6.514	1.916
40	5.306	1.752
45	4.348	1.587
50	3.583	1.426
55	2.968	1.278
60	2.467	1.136
65	2.068	1.007
70	1.739	0.891
75	1.469	0.785
80	1.246	0.691
85	1.061	0.607
90	0.908	0.533
95	0.779	0.469
100	0.672	0.414

## USB service outlet

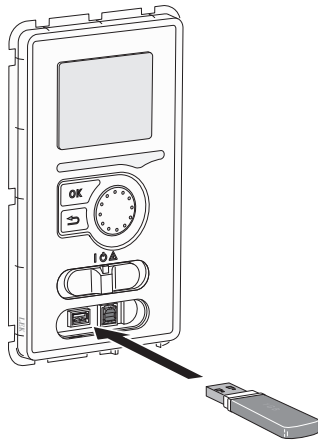

The display unit is equipped with a USB socket that can be used to update the software, save logged information and manage the settings in F370.

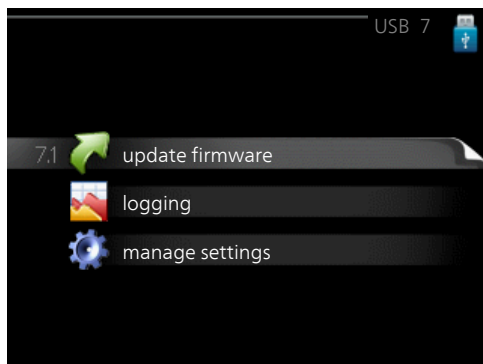
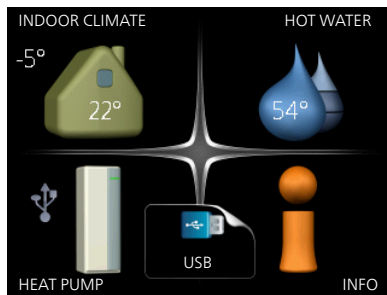

When a USB memory is connected a new menu (menu 7) appears in the display.

## Menu 7.1 - update firmware

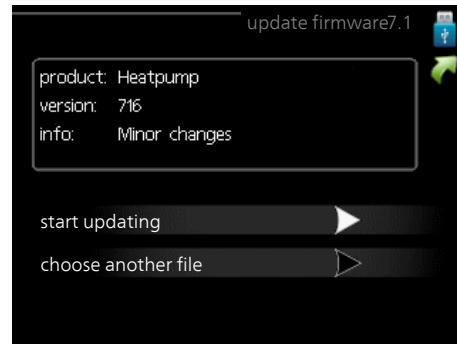

This allows you to update the software in F370.



### NOTE

For the following functions to work the USB memory must contain files with software for F370 from NIBE.

The fact box at the top of the display shows information (always in English) of the most probable update that the update software has selected from the USB memory.

This information states which product the software is intended for, the software version and general information about them. If you wish to select another file than the one selected, the correct file can be selected by "choose another file".

### start updating

Select "start updating" if you want to start the update. You are asked whether you really want to update the software. Respond "yes" to continue or "no" to undo.

If you responded "yes" to the previous question the update starts and you can now follow the progress of the update on the display. When the update is complete F370 restarts.



### NOTE

A software update does not reset the menu settings in F370.



### NOTE

If the update is interrupted before it is complete (for example power cut etc.), the software can be reset to the previous version if the OK button is held in during start up until the green lamp starts to illuminate (takes about 10 seconds).

### choose another file



Select "choose another file" if you do not want to use the suggested software. When you scroll through the files, information about the marked software is shown in a fact box just as before. When you have selected a file with the OK button you will return to the previous page (menu 7.1) where you can choose to start the update.

### Menu 7.2 - logging

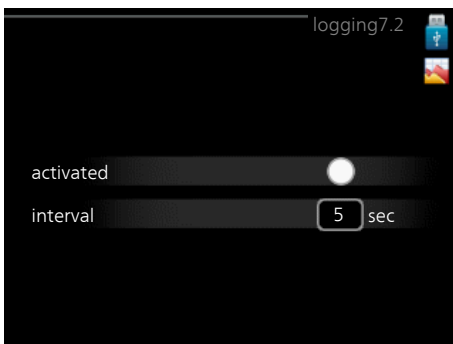

Setting range: 1 s – 60 min  
Factory setting range: 5 s

Here you can choose how current measurement values from F370 should be saved onto a log file on the USB memory.

1. Set the desired interval between loggings.
2. Tick "activated".
3. The present values from F370 are saved in a file in the USB memory at the set interval until "activated" is unticked.

**NOTE**  
Untick "activated" before removing the USB memory.

### Menu 7.3 - manage settings

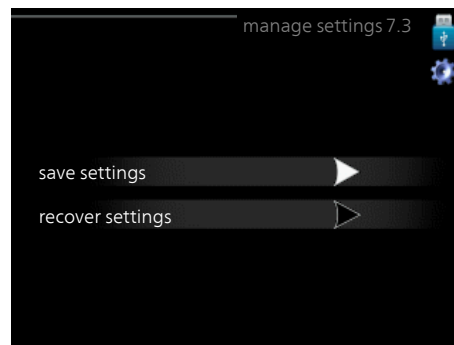

Here you can manage (save as or retrieve from) all the menu settings (user and service menus) in F370 with a USB memory.

Via "save settings" you save the menu settings to the USB memory in order to restore them later or to copy the settings to another F370.

**NOTE**  
When you save the menu settings to the USB memory you replace any previously saved settings on the USB memory.

Via "recover settings" you reset all menu settings from the USB memory.

**NOTE**  
Reset of the menu settings from the USB memory cannot be undone.

# 10 Disturbances in comfort

In most cases, the heat pump notes operational interference (operational interference can lead to disturbance in comfort) and indicates this with alarms and shows action instructions in the display.

## Info-menu

All the heat pump measurement values are gathered under menu 3.1 in the heat pump menu system. Looking through the values in this menu can often simplify finding the source of the fault. See help menu or user manual for more information about menu 3.1.

## Manage alarm

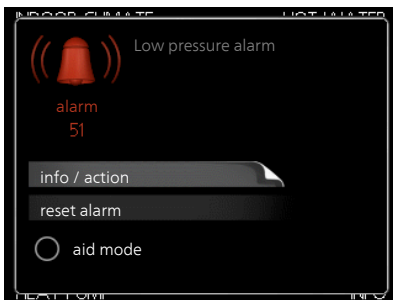

In the event of an alarm, some kind of malfunction has occurred, which is indicated by the status lamp changing from green continuously to red continuously. In addition, an alarm bell appears in the information window.

### Alarm

In the event of an alarm with a red status lamp a malfunction has occurred that the heat pump cannot remedy itself. In the display, by turning the control knob and pressing the OK button, you can see the type of alarm it is and reset it. You can also choose to set the heat pump to aid mode.

**info / action** Here you can read what the alarm means and receive tips on what you can do to correct the problem that caused the alarm.

**reset alarm** In most cases it is enough to select "reset alarm" to correct the problem that caused the alarm. If a green light illuminates after selecting "reset alarm" the alarm has been remedied. If a red light is still visible and a menu called "alarm" is visible in the display, the problem that caused the alarm remains. If the alarm disappears and then returns, see the section "Troubleshooting".

**aid mode** "aid mode" is a type of emergency mode. This means that the heat pump produces heat and/or hot water despite there being some kind of problem. This can mean that the heat pump's compressor is not running. In this case the immersion heater produces heat and/or hot water.



#### NOTE

To select aid mode an alarm action must be selected in the menu 5.1.4.



#### Caution

Selecting "aid mode" is not the same as correcting the problem that caused the alarm. The status lamp will therefore continue to be red.

## Troubleshooting

If the operational interference is not shown in the display the following tips can be used:

### Basic actions

Start by checking the following possible fault sources:

- The switch's (SF1) position.
- Group and main fuses of the accommodation.
- Earth-fault breaker.
- The heat pump's miniature circuit breaker (FA1).
- The heat pump's temperature limiter (FD1).
- Correctly set load monitor (if installed).

### Low hot water temperature or a lack of hot water

- Closed or choked filling valve (QM10) for the hot water heater.
  - Open the valve.
- Heat pump in incorrect operating mode.
  - Enter menu 4.2. If mode "auto" is selected, select a higher value on "stop additional heat" in menu 4.9.2.
  - If mode "manual" is selected, select "addition".
- Large hot water consumption.
  - Wait until the hot water has heated up. Temporarily increased hot water capacity (temporary lux) can be activated in menu 2.1.
- Too low hot water setting.
  - Enter menu 2.2 and select a higher comfort mode.

### Low room temperature

- Closed thermostats in several rooms.
  - See the "Saving tips" section in the User manual for more detailed information about how to best set the thermostats.
- Heat pump in incorrect operating mode.
  - Enter menu 4.2. If mode "auto" is selected, select a higher value on "stop heating" in menu 4.9.2.
  - If mode "manual" is selected, select "heating". If this is not enough, select "addition".
- Too low set value on the automatic heating control.
  - Enter menu 1.1 "temperature" and adjust the offset heating curve up. If the room temperature is only low in cold weather the curve slope in menu 1.9.1 "heating curve" needs adjusting up.
- "comfort mode" "luxury" selected in combination with large hot water outlet.
  - Enter menu 2.2 and select "economy" or "normal".

- "Holiday mode" activated in menu 4.7.
  - Enter menu 4.7 and select "Off".
- External switch for changing the room heating activated.
  - Check any external switches.
- Circulation pump (GP6) has stopped.
  - See section "Helping the circulation pump to start" on page 50.
- Air in the heating system.
  - Vent the heating system (see page 32).
- Closed valves (QM31), (QM32) to the heating system.
  - Open the valves.

### High room temperature

- Too high set value on the automatic heating control.
  - Enter menu 1.1 (temperature) and reduce the offset heating curve. If the room temperature is only high in cold weather the curve slope in menu 1.9.1 "heating curve" needs adjusting down.
- External switch for changing the room heating activated.
  - Check any external switches.

### Low system pressure

- Not enough water in the heating system.
  - Top up the water in the heating system (see page 32).

### Low or a lack of ventilation

- Filter (HQ10) blocked.
  - Clean or replace the filter.
- The ventilation is not adjusted.
  - Order/implement ventilation adjustment.
- Exhaust air device blocked or throttled down too much.
  - Check and clean the exhaust air devices.
- Fan speed in reduced mode.
  - Enter menu 1.2 and select "normal".
- External switch for changing the fan speed activated.
  - Check any external switches.

### High or distracting ventilation

- Filter (HQ10) blocked.
  - Clean or replace the filter.
- The ventilation is not adjusted.
  - Order/implement ventilation adjustment.
- Fan speed in forced mode.
  - Enter menu 1.2 and select "normal".
- External switch for changing the fan speed activated.
  - Check any external switches.

### The compressor does not start

- There is no heating requirement.
  - The heat pump does not call on heating nor hot water.
  - The heat pump defrosts.
- Temperature conditions tripped.
  - Wait until the temperature condition has been reset.
- Minimum time between compressor starts has not been reached.
  - Wait 30 minutes and then check if the compressor has started.
- Alarm tripped.
  - Follow the display instructions.

# 11 Accessories

Not all accessories are available on all markets.

## Communications module SMS 40

When there is no internet connection, you can use the accessory SMS 40 to control F370 via SMS.

Part no 067 073

## Docking kit DEH

There are separate docking kits available for connecting other heat sources to the heat pump.

### Docking kit wood/oil/pellets DEH 40

Part no. 066 101

### Docking kit gas DEH 41

Part no. 066 102

### Docking kit Solar 41

Solar 41 means that F370 together with e.g. NIBE UKVS 230 can be connected to thermal solar heating.

Part no. 067 127

## Extra shunt group ECS 40/ECS 41

This accessory is used when F370 is installed in houses with two or more different heating systems that require different supply temperatures.

### ECS 40 (Max 80 m<sup>2</sup>)

Part no 067 287

### ECS 41 (approx. 80-250 m<sup>2</sup>)

Part no 067 288

## Room unit RMU 40

RMU 40 means that control and monitoring of F370 can be carried out in a different part of your home to where it is located.

Part no 067 064

## Top cabinet

Top cabinet that conceals the ventilation ducts.

### 245 mm

Part no. 067 517

### 385-635 mm

Part no. 067 519

### 345 mm

Part no. 067 518

## Water heater/Accumulator tank

### Eminent

Water heater with immersion heater.

#### Eminent 35

Copper Part no. 072 310

Enamel Part no. 072 300

Stainless Part no. 072 320

#### Eminent 55

Copper Part no. 072 340

Enamel Part no. 072 330

Stainless Part no. 072 350

#### Eminent 100

Copper Part no. 072 370

Enamel Part no. 072 360

Stainless Part no. 072 380

#### Eminent 120

Stainless Part no. 072 384

### Compact

Water heater with immersion heater.

#### Compact 100

Copper Part no. 084 010

#### Compact 200

Copper Part no. 084 020

Enamel Part no. 084 070

Stainless Part no. 084 050

#### Compact 300

Copper Part no. 084 030

Enamel Part no. 084 080

Stainless Part no. 084 060

# 12 Technical data

## Dimensions and setting-out coordinates

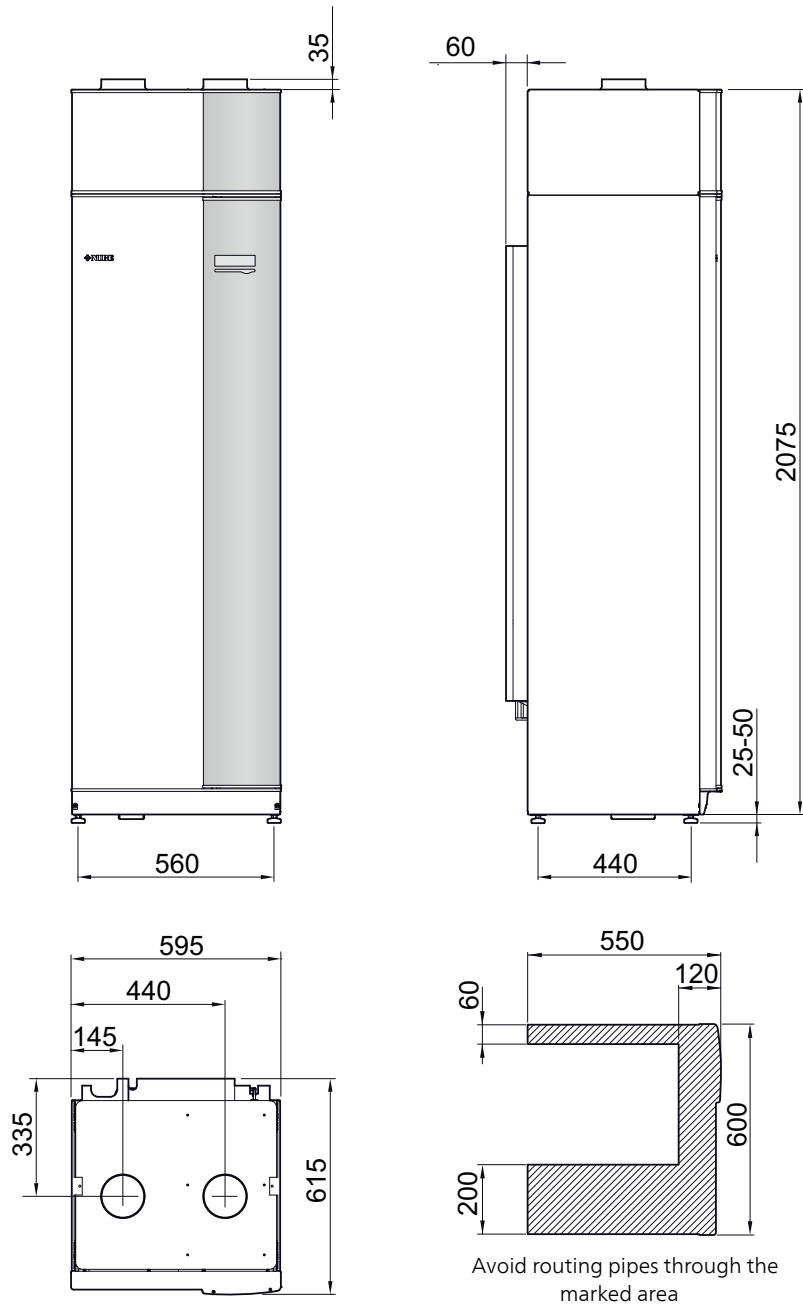



## Technical specifications



3x400 V		Rostfritt
<b>Output data according to EN 14 511</b>		
Specified heating output ( $P_H$ ) <sup>1</sup>	kW	2.18
COP <sup>1</sup>		3.93
Specified heating output ( $P_H$ ) <sup>2</sup>	kW	2.03
COP <sup>2</sup>		3.24
Specified heating output ( $P_H$ ) <sup>3</sup>	kW	1.88
COP <sup>3</sup>		2.74
<b>Additional power</b>		
Max power, immersion heater (factory setting)	kW	10.3 (5.6)
<b>Electrical data</b>		
Rated voltage	V	400 V 3N ~ 50Hz
Max operating current	A	20.3
Min. fuse rating	A	10
Drive output heating medium pump	W	4-34
Driving power exhaust air fan	W	10-130
Enclosure class		IP 21
<b>Refrigerant circuit</b>		
Type of refrigerant		R290, propan
Volume	kg	0.4
Cut-out value pressostat HP	MPa/bar	2.45 / 24.5
Cut-out value pressostat LP	MPa/bar	0.15 / 1.5
<b>Heating medium circuit</b>		
Opening pressure, safety valve	MPa/bar	0.25 / 2.5
Max temperature, supply line (factory setting)	°C	70 (60)
<b>Ventilation</b>		
Min. air flow at exhaust air temperature at least 20°C	l/s	28
Min. air flow at exhaust air temperature below 20°C	l/s	31
<b>Sound effect level according to EN 12 102</b>		
Sound power level ( $L_{W(A)}$ ) <sup>4</sup>	dB(A)	46.5-48.0
<b>Sound pressure levels</b>		
Sound pressure level in the boiler room ( $L_{P(A)}$ ) <sup>5</sup>	dB(A)	42.5-44.0
<b>Pipe connections</b>		
Heating medium ext Ø	mm	22
Hot water ext Ø	mm	22
Cold water ext Ø	mm	22
Docking ext Ø	mm	22
Ventilation Ø	mm	125

Other 3x400 V		Rostfritt
<b>Water heater and heating section</b>		
Volume heating section	litre	70
Volume, hot water heater	litre	170
Max pressure in hot water heater	MPa/bar	1.0 / 10.0
<b>Capacity, hot water</b>		
Tap volume 40 °C according to EN 16 147( $V_{max}$ ) <sup>6,7</sup>	litre	217
COP at Normal comfort ( $COP_t$ )		1.88
Idle loss at Normal comfort ( $P_{es}$ )	W	54
<b>Dimensions and weight</b>		
Width	mm	600
Depth	mm	616
Height incl. feet		2,100 - 2,125
Required ceiling height	mm	2,270
Weight	kg	195
Part No.		066 056

<sup>1</sup>A20(12)W35, exhaust air flow 56 l/s (200 m<sup>3</sup>/h)

<sup>2</sup>A20(12)W45, exhaust air flow 42 l/s (150 m<sup>3</sup>/h)

<sup>3</sup>A20(12)W55, exhaust air flow 31 l/s (110 m<sup>3</sup>/h)

<sup>4</sup>The value varies with the selected fan curve. For more extensive sound data including sound to channels visit [www.nibe.eu](http://www.nibe.eu).

<sup>5</sup> The value can vary with the room's damping capacity. These values apply at a damping of 4 dB.

<sup>6</sup>A20(12) exhaust air flow 42 l/s (150 m<sup>3</sup>/h)

<sup>7</sup>Comfort mode, normal

3x230 V		Rostfritt
<b>Output data according to EN 14 511</b>		
Specified heating output ( $P_H$ ) <sup>1</sup>	kW	2.18
COP <sup>1</sup>		3.93
Specified heating output ( $P_H$ ) <sup>2</sup>	kW	2.03
COP <sup>2</sup>		3.24
Specified heating output ( $P_H$ ) <sup>3</sup>	kW	1.88
COP <sup>3</sup>		2.74
<b>Additional power</b>		
Max power, immersion heater (factory setting)	kW	10.0 (6.67)
<b>Electrical data</b>		
Rated voltage	V	230 V 3N ~ 50 Hz
Max operating current	A	31.1
Min. fuse rating	A	10
Drive output heating medium pump	W	4-34
Driving power exhaust air fan	W	10-130
Enclosure class		IP 21
<b>Refrigerant circuit</b>		
Type of refrigerant		R290, propan
Volume	kg	0.4
Cut-out value pressostat HP	MPa/bar	2.45 / 24.5
Cut-out value pressostat LP	MPa/bar	0.15 / 1.5
<b>Heating medium circuit</b>		
Opening pressure, safety valve	MPa/bar	0.25 / 2.5
Max temperature, supply line (factory setting)	°C	70 (60)
<b>Ventilation</b>		
Min. air flow at exhaust air temperature at least 20°C	l/s	28
Min. air flow at exhaust air temperature below 20°C	l/s	31
<b>Sound effect level according to EN 12 102</b>		
Sound power level ( $L_{W(A)}$ ) <sup>4</sup>	dB(A)	46.5-48.0
<b>Sound pressure levels</b>		
Sound pressure level in the boiler room ( $L_{P(A)}$ ) <sup>5</sup>	dB(A)	42.5-44.0
<b>Pipe connections</b>		
Heating medium ext Ø	mm	22
Hot water ext Ø	mm	22
Cold water ext Ø	mm	22
Docking ext Ø	mm	22
Ventilation Ø	mm	125

Other 3x230 V		Rostfritt
<b>Water heater and heating section</b>		
Volume heating section	litre	70
Volume, hot water heater	litre	170
Max pressure in hot water heater	MPa/bar	1.0 / 10.0
<b>Capacity, hot water</b>		
Tap volume 40 °C according to EN 16 147( $V_{max}$ ) <sup>6,7</sup>	litre	281
COP at Normal comfort ( $COP_t$ )		1.88
Idle loss at Normal comfort ( $P_{es}$ )	W	54
<b>Dimensions and weight</b>		
Width	mm	600
Depth	mm	616
Height incl. feet		2,100 - 2,125
Required ceiling height	mm	2,270
Weight	kg	199
Part No.		066 059

<sup>1</sup>A20(12)W35, exhaust air flow 56 l/s (200 m<sup>3</sup>/h)

<sup>2</sup>A20(12)W45, exhaust air flow 42 l/s (150 m<sup>3</sup>/h)

<sup>3</sup>A20(12)W55, exhaust air flow 31 l/s (110 m<sup>3</sup>/h)

<sup>4</sup>The value varies with the selected fan curve. For more extensive sound data including sound to channels visit [www.nibe.eu](http://www.nibe.eu).

<sup>5</sup> The value can vary with the room's damping capacity. These values apply at a damping of 4 dB.

<sup>6</sup>A20(12) exhaust air flow 42 l/s (150 m<sup>3</sup>/h)

<sup>7</sup>Comfort mode, normal

# Energy labelling

## Information sheet

Supplier		NIBE
Model		F370
Temperature application	°C	35 / 55
Declared load profile for water heating		<b>L</b>
Seasonal space heating energy efficiency class, average climate		<b>A+ / A+</b>
Water heating energy efficiency class, average climate		<b>A</b>
Rated heat output (P <sub>designh</sub> ), average climate	kW	3 / 3
Annual energy consumption space heating, average climate	kWh	1598 / 1898
Annual energy consumption water heating, average climate	kWh	1361
Seasonal space heating energy efficiency, average climate	%	131 / 110
Water heating energy efficiency, average climate	%	75
Sound power level L <sub>WA</sub> indoors	dB	47
Rated heat output (P <sub>designh</sub> ), cold climate	kW	3 / 3
Rated heat output (P <sub>designh</sub> ), warm climate	kW	3 / 3
Annual energy consumption space heating, cold climate	kWh	1808 / 2162
Annual energy consumption water heating, cold climate	kWh	1361
Annual energy consumption space heating, warm climate	kWh	1081 / 1276
Annual energy consumption water heating, warm climate	kWh	1361
Seasonal space heating energy efficiency, cold climate	%	139 / 116
Water heating energy efficiency, cold climate	%	75
Seasonal space heating energy efficiency, warm climate	%	126 / 106
Water heating energy efficiency, warm climate	%	75
Sound power level L <sub>WA</sub> outdoors	dB	- / -

## Data for energy efficiency of the package

Model		F370
Temperature application	°C	35 / 55
Controller, class		VII
Controller, contribution to efficiency	%	3.5
Seasonal space heating energy efficiency of the package, average climate	%	135 / 114
Seasonal space heating energy efficiency class of the package, average climate		<b>A+ / A+</b>
Seasonal space heating energy efficiency of the package, cold climate	%	142 / 119
Seasonal space heating energy efficiency of the package, warm climate	%	129 / 109

The reported efficiency of the package also takes the controller into account. If an external supplementary boiler or solar heating is added to the package, the overall efficiency of the package should be recalculated.

## Technical documentation

Model				F370							
Type of heat pump				<input type="checkbox"/> Air-water <input checked="" type="checkbox"/> Exhaust-water <input type="checkbox"/> Brine-water <input type="checkbox"/> Water-water							
Low-temperature heat pump				<input type="checkbox"/> Yes <input checked="" type="checkbox"/> No							
Integrated immersion heater for additional heat				<input checked="" type="checkbox"/> Yes <input type="checkbox"/> No							
Heat pump combination heater				<input checked="" type="checkbox"/> Yes <input type="checkbox"/> No							
Climate				<input checked="" type="checkbox"/> Average <input type="checkbox"/> Cold <input type="checkbox"/> Warm							
Temperature application				<input checked="" type="checkbox"/> Average (55 °C) <input type="checkbox"/> Low (35 °C)							
Applied standards				EN14825, EN16147							
<b>Rated heat output</b>		Prated	2,6	kW	<b>Seasonal space heating energy efficiency</b>		$\eta_s$	110	%		
<i>Declared capacity for space heating at part load and at outdoor temperature <math>T_j</math></i>					<i>Declared coefficient of performance for space heating at part load and at outdoor temperature <math>T_j</math></i>						
$T_j = -7\text{ °C}$	Pdh	1.7	kW	$T_j = -7\text{ °C}$	COPd	2.72	-				
$T_j = +2\text{ °C}$	Pdh	1.7	kW	$T_j = +2\text{ °C}$	COPd	3.22	-				
$T_j = +7\text{ °C}$	Pdh	1.7	kW	$T_j = +7\text{ °C}$	COPd	3.37	-				
$T_j = +12\text{ °C}$	Pdh	1.7	kW	$T_j = +12\text{ °C}$	COPd	3.28	-				
$T_j = \text{biv}$	Pdh	1.7	kW	$T_j = \text{biv}$	COPd	3.04	-				
$T_j = \text{TOL}$	Pdh	1.7	kW	$T_j = \text{TOL}$	COPd	2.56	-				
$T_j = -15\text{ °C}$ (if TOL < -20 °C)	Pdh		kW	$T_j = -15\text{ °C}$ (if TOL < -20 °C)	COPd		-				
Bivalent temperature				$T_{\text{biv}}$	-1.6	°C	Min. outdoor air temperature		TOL	-10	°C
Cycling interval capacity				P <sub>cy</sub>		kW	Cycling interval efficiency		COP <sub>cy</sub>		-
Degradation coefficient				C <sub>dh</sub>	0.96	-	Max supply temperature		WTOL	58	°C
<i>Power consumption in modes other than active mode</i>					<i>Additional heat</i>						
Off mode		P <sub>OFF</sub>	0.002	kW	Rated heat output			P <sub>sup</sub>	0.9	kW	
Thermostat-off mode		P <sub>TO</sub>	0.02	kW							
Standby mode		P <sub>SB</sub>	0.015	kW	Type of energy input			Electric			
Crankcase heater mode		P <sub>CK</sub>	0.024	kW							
<i>Other items</i>											
Capacity control		Fixed			Rated airflow (air-water)				150	m <sup>3</sup> /h	
Sound power level, indoors/outdoors		L <sub>WA</sub>	47 / - / -	dB	Nominal heating medium flow				0.18	m <sup>3</sup> /h	
Annual energy consumption		Q <sub>HE</sub>	1,898	kWh	Brine flow brine-water or water-water heat pumps					m <sup>3</sup> /h	
<i>For heat pump combination heater</i>											
<b>Declared load profile for water heating</b>				L		<b>Water heating energy efficiency</b>			$\eta_{\text{wh}}$	75	%
Daily energy consumption		Q <sub>elec</sub>	6.20	kWh	Daily fuel consumption			Q <sub>fuel</sub>		kWh	
Annual energy consumption		AEC	1,361	kWh	Annual fuel consumption			AFC		GJ	

# Electrical circuit diagram

3x400V

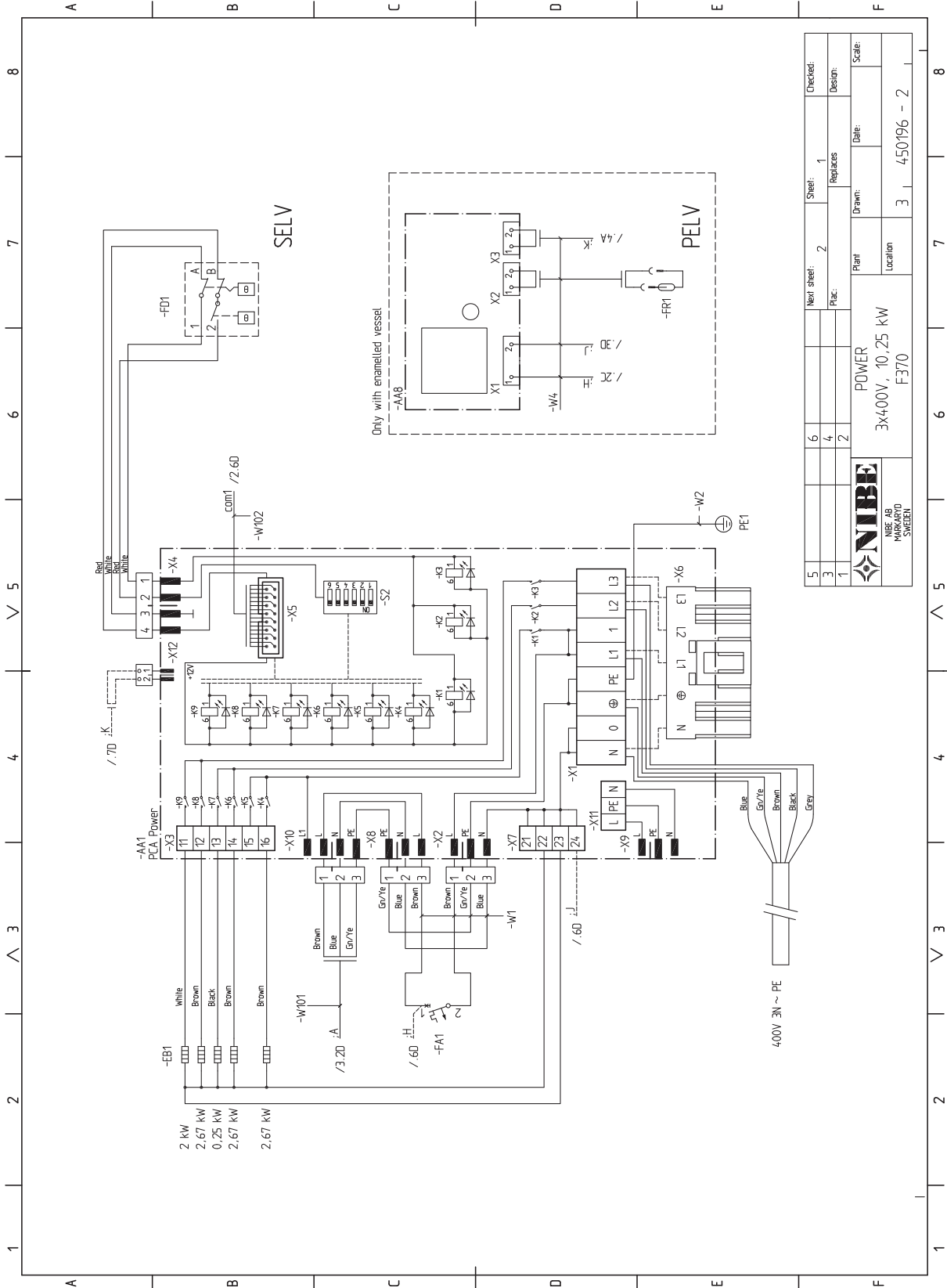

5		Next sheet:	2	Sheet:	1	Checked:
3		Replaces:				Design:
1		Plant:		Drawn:		Scale:
NIBE			POWER		Date:	
NIBE AB			3x400V, 10,25 kW		450196 - 2	
MARKARYD			F370		Location	
SWELEN						

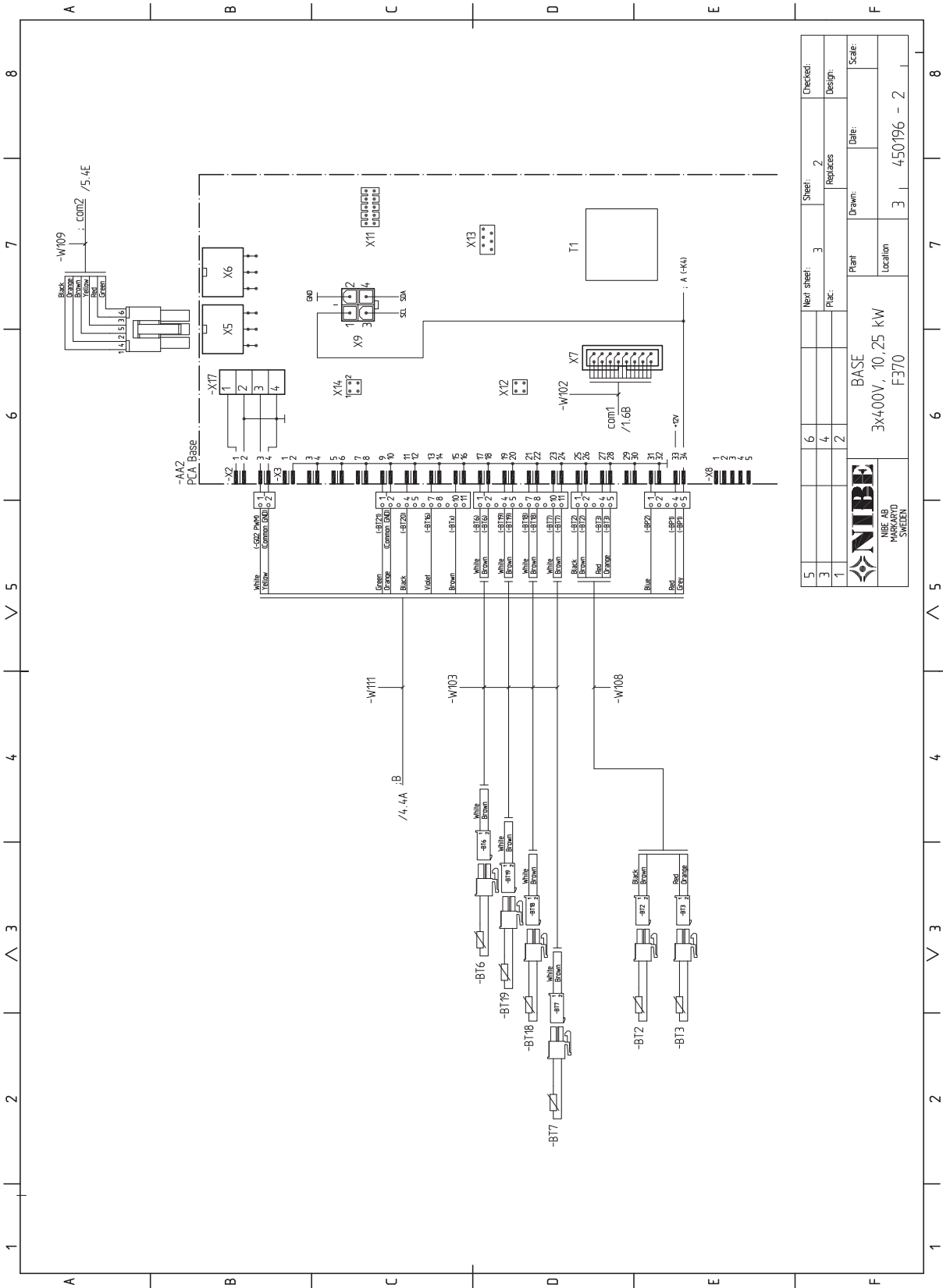

5				Next sheet:	3	Sheet:	2	Checked:	
3				Replaces:				Design:	
1				Plant:				Date:	
<b>NIBE</b> NIBE AB HÄRVEDEN SWELEN				BASE 3x400V, 10,25 KW F370		Location 3 450196 - 2		Scale :	





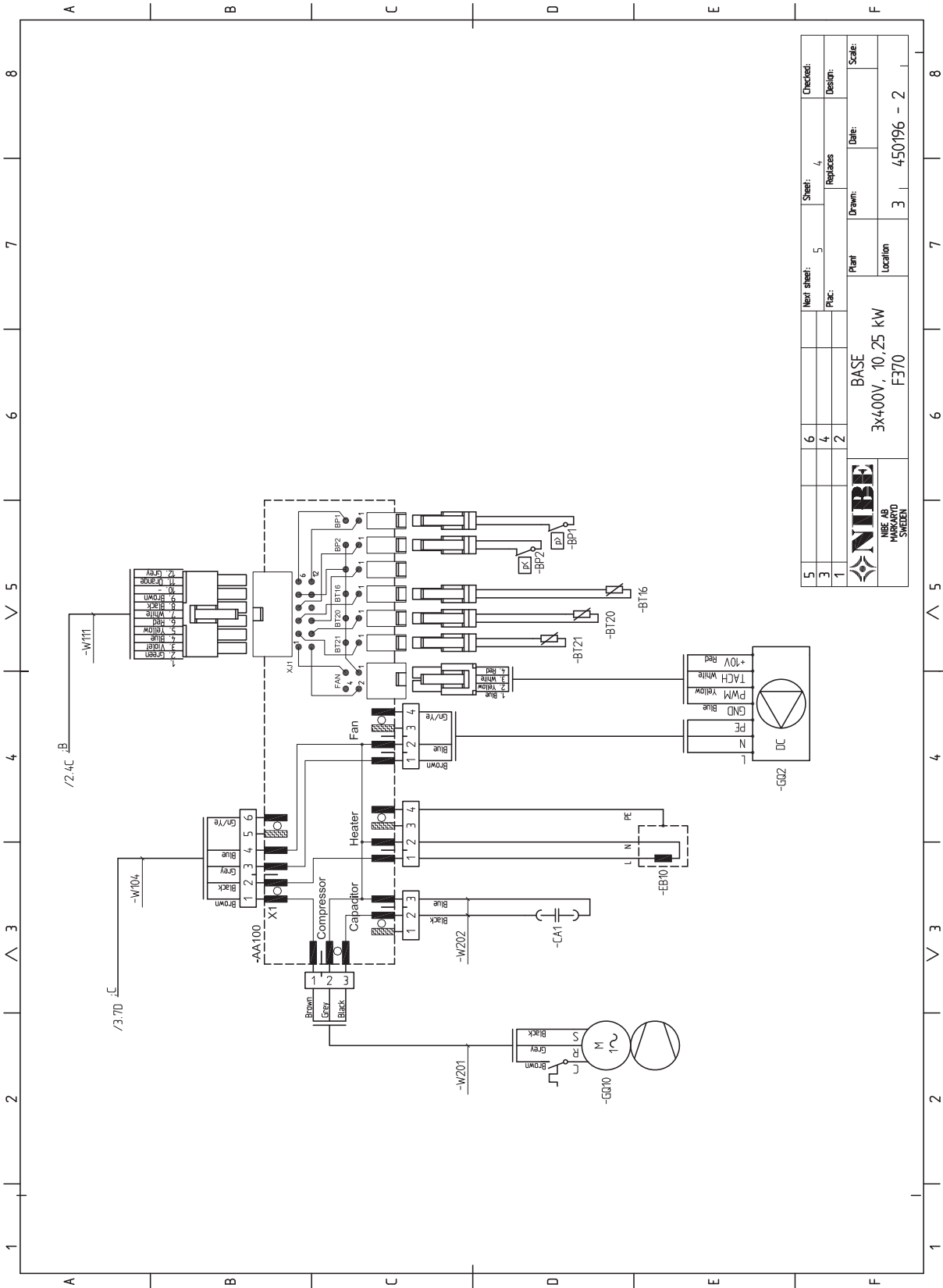

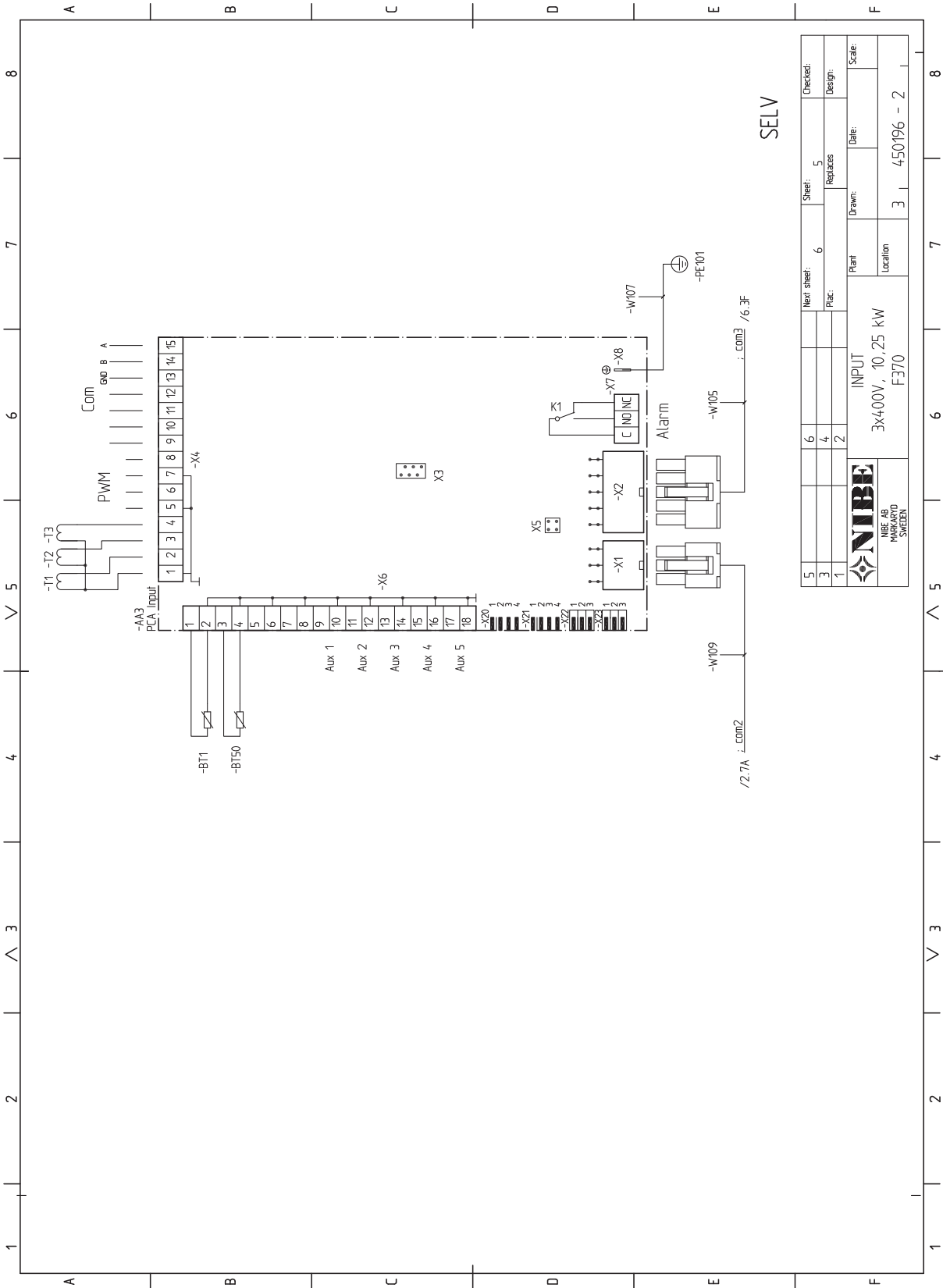

5				Next sheet:	5	Sheet:	4	Checked:
3				Plac:		Replaces		Design:
1								Scale:
				Plant	BASE		Date:	
				Location	3x400V, 10.25 kW			
					F370		3	450196 - 2
				<b>NIBE</b> NIBE AB MÖCKELAVÄG SWELEN				

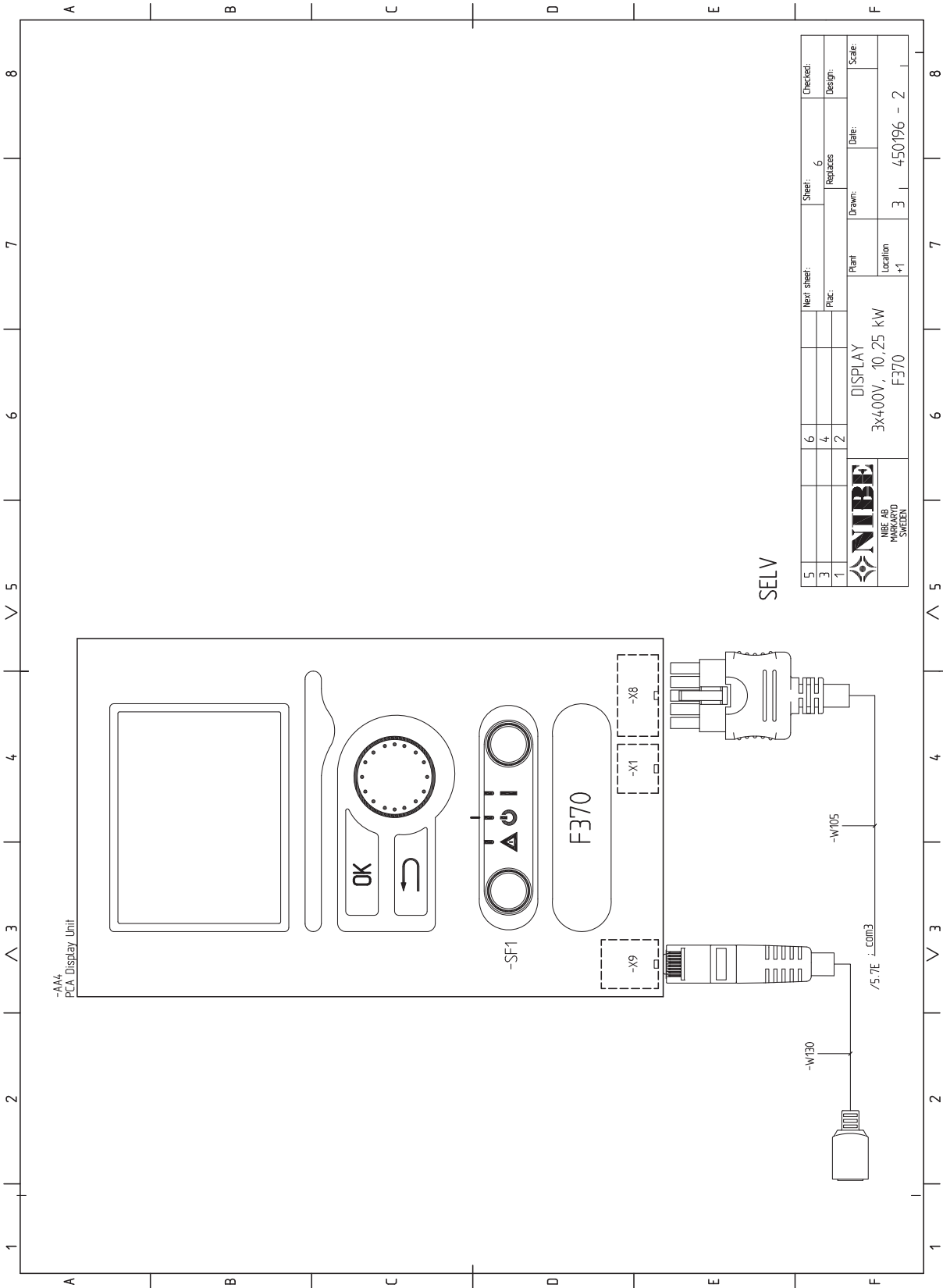



SELV

5				Next sheet:	Sheet:	Checked:
3	6	4	2	Replaces	6	Design:
1				Plant	Drawn	Date:
 <b>NIBE</b> NIBE AB HÄRGARÅD SWELEN		DISPLAY		Location	Scale:	
		3x400V, 10,25 KW		+1	4-50196 - 2	
		F370				

# 3x230V

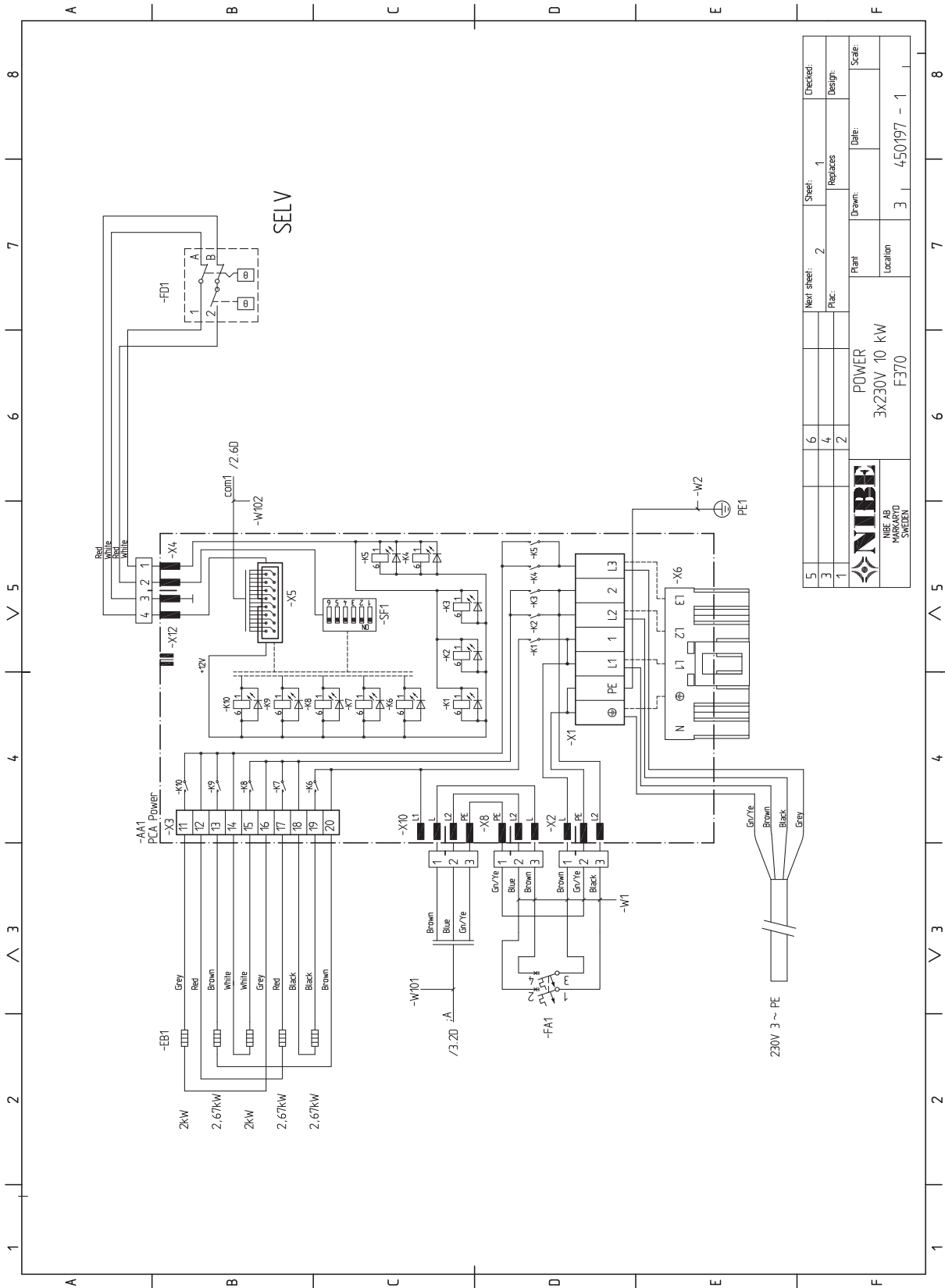

5	Next sheet:	2	Sheet:	1	Checked:
3	Replaces:				Design:
1	Plant:		Drawn:		Scale:
POWER			Date:		
3x230V 10 kW			Location:	3	450197 - 1
F370					



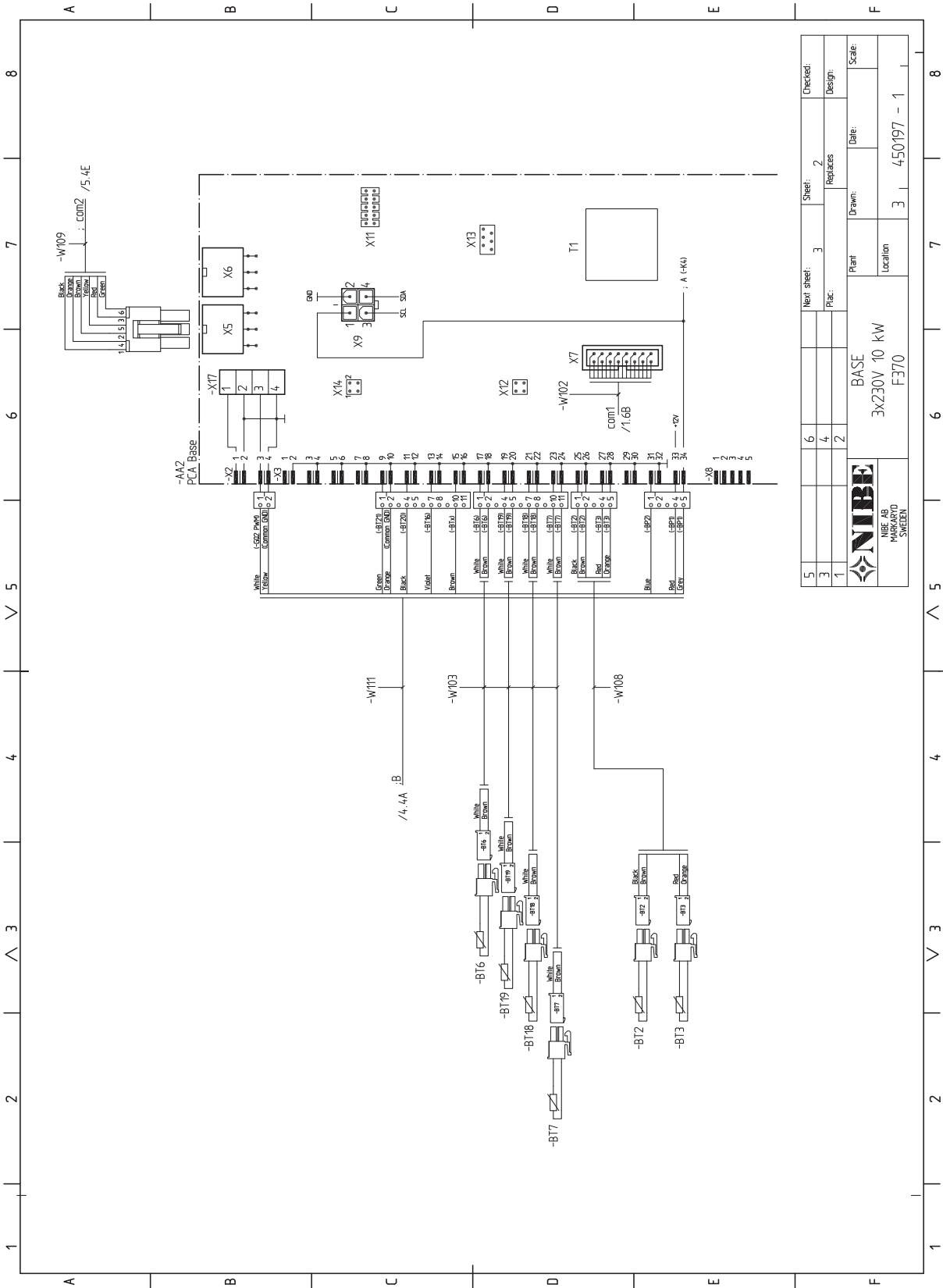

5	Next sheet:	3	Sheet:	2	Checked:
3	Replaces:				Design:
1	Plant:		Drawn:		Scale:
	Location:		Date:		
 <b>NIBE AB</b> HÄRSTAD SWELEN			<b>BASE</b> <b>3X230V 10 kW</b> <b>F370</b>		
			3 450197 - 1		

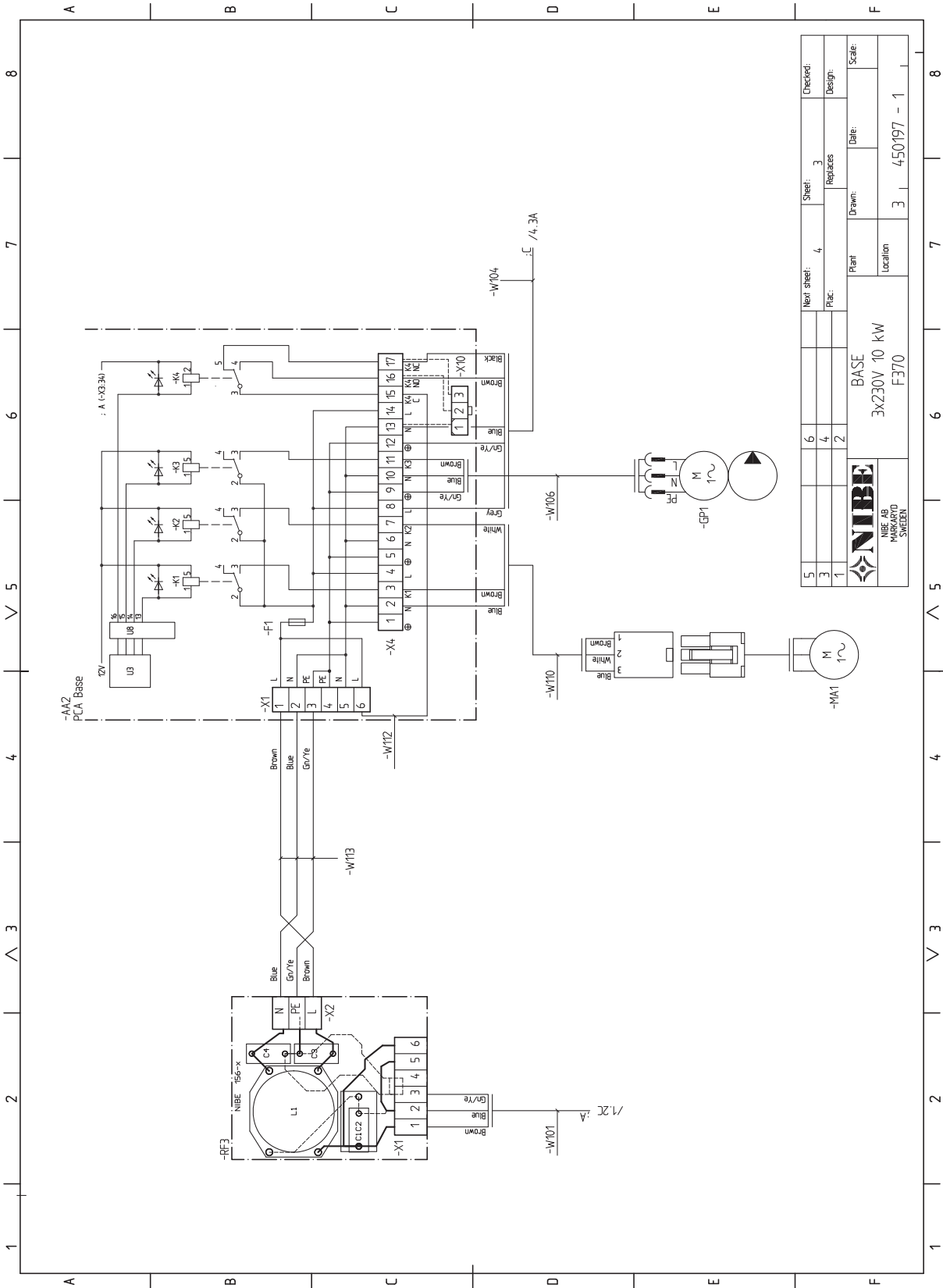

5	Next sheet:	4	Sheet:	3	Checked:
3	Replaces:				Design:
1	Plant:	BASE	Drawn:		Scale:
	Location:	3X230V 10 kW	Date:		
		F370	3	450197 - 1	



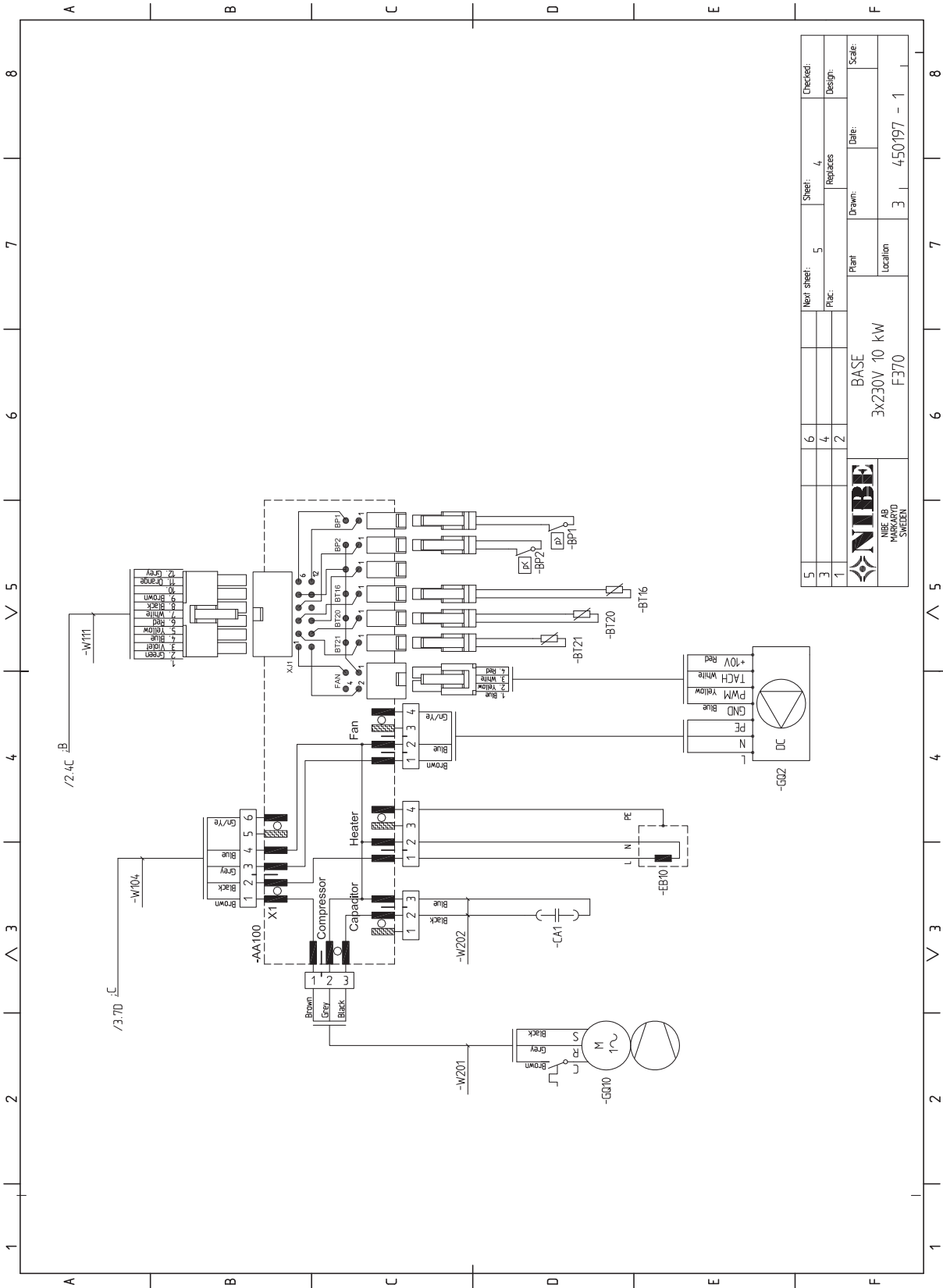

5	6	Next sheet:	5	Sheet:	4	Checked:
3	4	Replaces				Design:
1	2	Plant	BASE	Drawn:		Scale:
		Location	3X230V 10 kW F370	Date:		
 NIBE AB MÅRKARND SWELEN			3	450197	- 1	



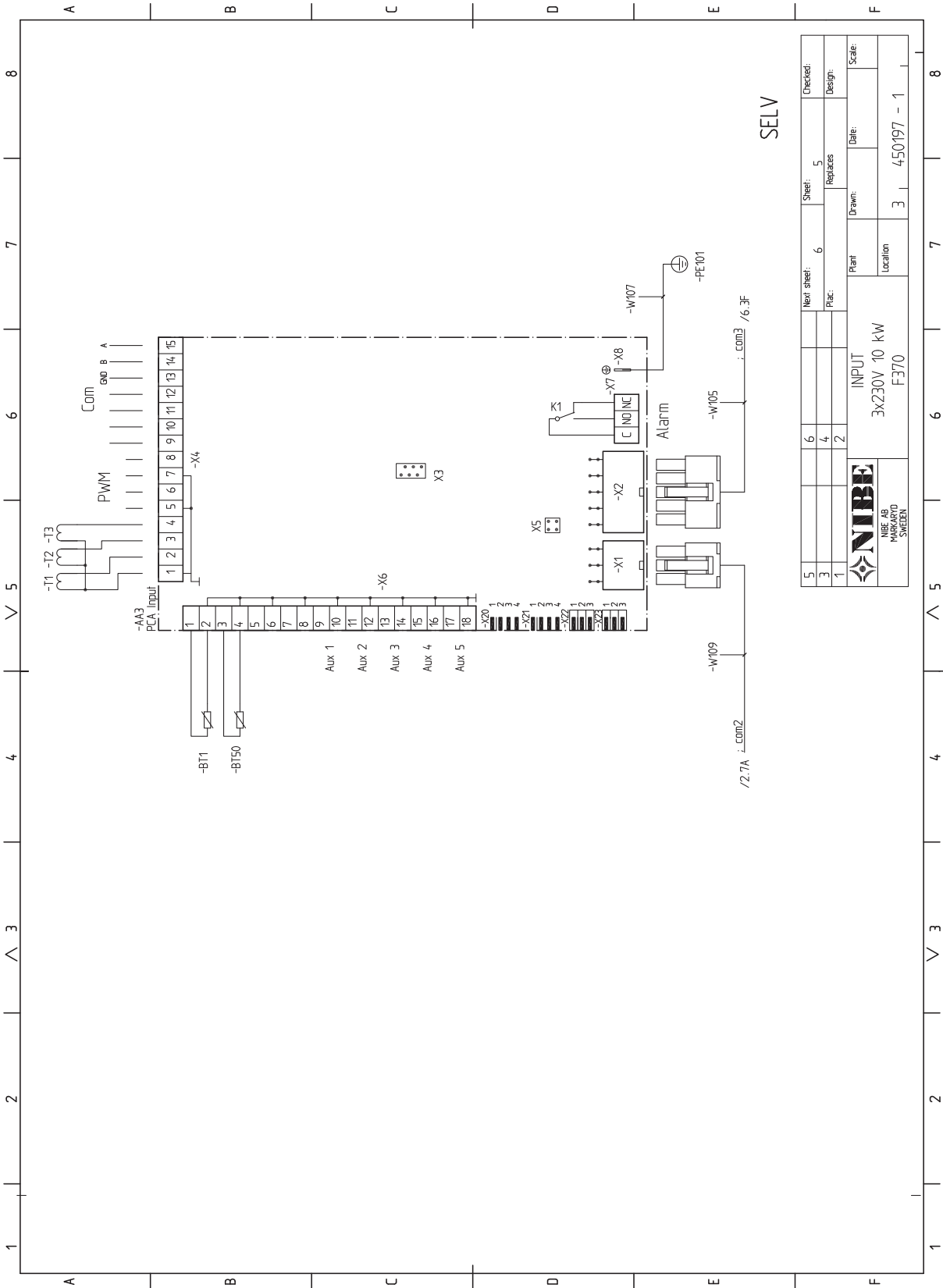

SELV

5	6	Next sheet:	6	Sheet:	5	Checked:
3	4	Replaces:				Design:
1	2	Plant:		Drawn:		Scale:
 NIBE AB HÄRGARÅD SWELEN			Location:	Date:		
INPUT						
3x230V 10 kW						
F370						
			Location:	Date:		
					3	450197 - 1

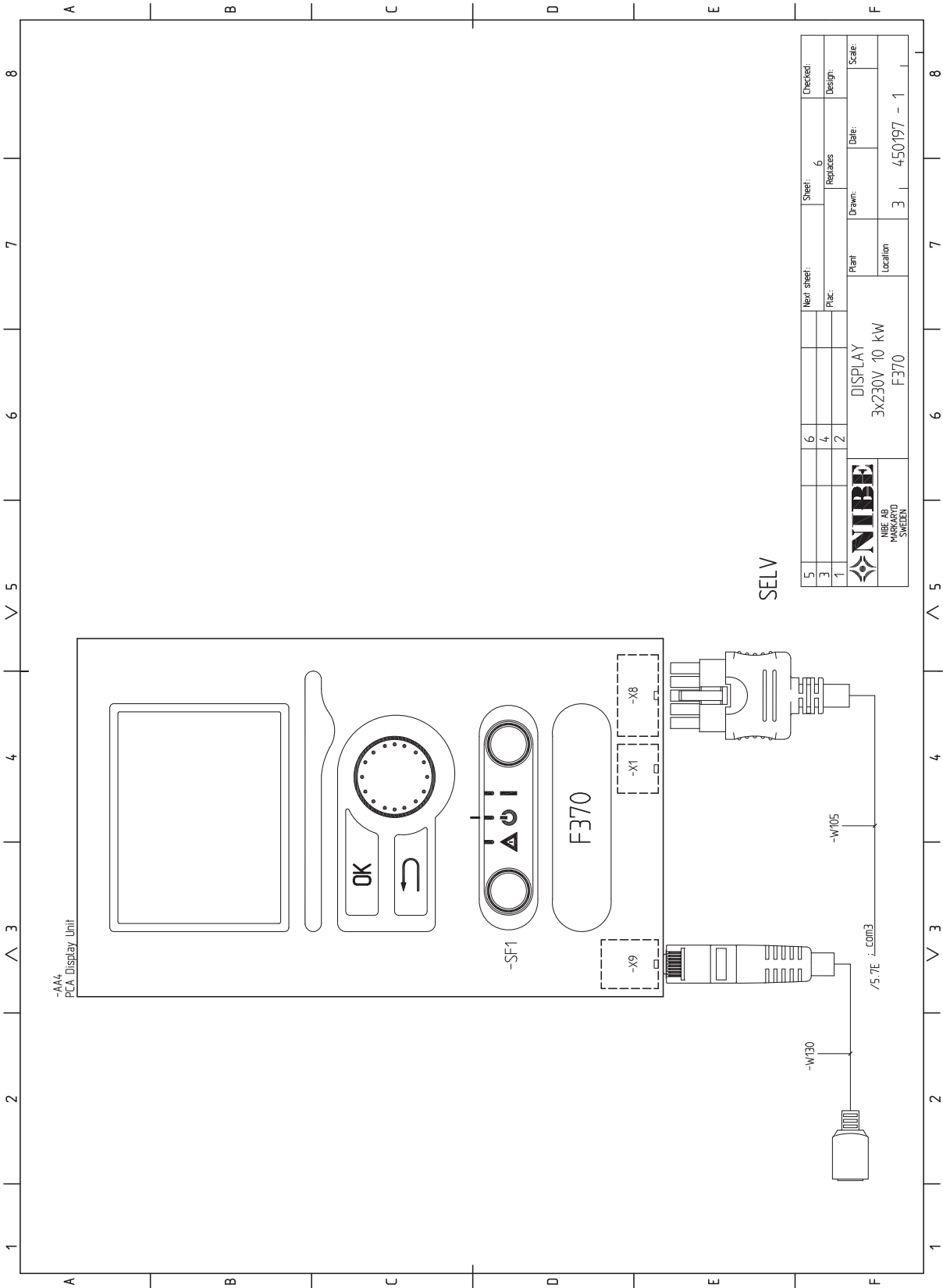

-AA4/  
PCA Display Unit

SELV

5				Next sheet:	Sheet:	6	Checked:
3		6		Replaces	Replaces	6	Design:
1		4			2		Scale:
				Plant	Drawn	Date:	
				DISPLAY			
				3x230V 10 kW			
				F370			
				Location		3   450197 - 1	



# 13 Item register

## Item register

### A

Accessibility, electrical connection, 22  
Accessories, 55  
Adjusting ventilation, 20  
Alarm, 53  
Assembly, 12

### B

Back button, 38

### C

Cable lock, 22  
Cold and hot water, 18  
Commissioning and adjusting, 32  
    Filling and venting, 32  
    Preparations, 32  
    Start guide, 33  
    Start-up and inspection, 33  
Connecting accessories, 31  
Connecting cold and hot water, 18  
Connecting current sensors, 28  
Connecting external operating voltage for the control system, 24  
Connecting the climate system, 18  
Connections, 23  
Contact for activation of fan speed, 30  
Contact for activation of "external adjustment", 30  
Contact for activation of "temporary lux", 30  
Contact for external tariff blocking, 29  
Control, 38, 42  
    Control - Introduction, 38  
    Control - Menus, 42  
Control - Introduction, 38  
    Display unit, 38  
    Menu system, 39  
Control knob, 38  
Control - Menus, 42  
    Menu 5 - SERVICE, 44

### D

Delivery and handling, 12  
    Assembly, 12  
    Installation area, 12  
    Removing parts of the insulation, 13  
    Removing the covers, 13  
    Supplied components, 13  
    Transport, 12  
Dimensions and pipe connections, 17  
Dimensions and setting-out coordinates, 56  
Display, 38  
Display unit, 38  
    Back button, 38  
    Control knob, 38  
    Display, 38  
    OK button, 38  
    Status lamp, 38  
    Switch, 38  
Disturbances in comfort, 53  
    Alarm, 53  
    Manage alarm, 53  
    Troubleshooting, 53  
Draining the climate system, 49  
Draining the hot water heater, 49

### E

Electrical addition - maximum output, 26  
Electrical circuit diagram, 63  
    3x230V, 69  
Electrical connections, 21  
    Accessibility, electrical connection, 22

Cable lock, 22  
Connecting accessories, 31  
Connecting external operating voltage for the control system, 24  
Connections, 23  
Electrical addition - maximum output, 26  
External connection options, 28  
    General, 21  
    Load monitor, 28  
    Miniature circuit-breaker, 21  
    NIBE Uplink, 28  
    Optional connections, 28  
    Outdoor sensor, 24  
    Output locking, 26  
    Power connection, 23  
    Removing the cover, base board, 22  
    Removing the cover, immersion heater circuit board, 22  
    Removing the hatch, input circuit board, 22  
    Room sensor, 25  
    Settings, 26  
    Standby mode, 26  
    Temperature limiter, 21  
Electrical wiring diagram  
    3x400V, enamel and stainless steel, 63  
Energy labelling, 61  
    Data for energy efficiency of the package, 61  
    Information sheet, 61  
    Technical documentation, 62  
Exhaust air duct, 20  
External connection options, 28  
    Contact for activation of fan speed, 30  
    Contact for activation of "external adjustment", 30  
    Contact for activation of "temporary lux", 30  
    Contact for external tariff blocking, 29  
    Possible selection for AUX inputs, 29  
    Possible selection for AUX output (potential free variable relay), 30  
    Switch for "Smart Grid ready", 29  
    Switch for external blocking of addition and/or compressor, 29  
    Switch for external blocking of heating, 29–30

### F

Filling and venting, 32  
    Filling the climate system, 32  
    Filling the hot water heater, 32  
    Venting the climate system, 32  
Filling the climate system, 32  
Filling the hot water heater, 32

### H

Handling, 4  
Heating medium side, 18  
Helping the circulation pump to start, 50  
Help menu, 33, 41

### I

Important information, 4  
    Recovery, 10  
Inspection of the installation, 11  
Installation alternative, 19  
    Connecting hot water circulation, 19  
    Extra hot water heaters, 19  
    Two or more climate systems, 19  
    Water heater with immersion heater, 19  
Installation area, 12

### M

Manage alarm, 53  
Marking, 4  
Menu 5 - SERVICE, 44

- Menu system, 39
  - Help menu, 33, 41
  - Operation, 40
  - Scroll through the windows, 41
  - Selecting menu, 40
  - Selecting options, 40
  - Setting a value, 40
  - Use the virtual keyboard, 41
- Miniature circuit-breaker, 21
- N**
- NIBE Uplink, 28
- O**
- OK button, 38
- Operation, 40
- Optional connections, 28
- Outdoor sensor, 24
- Output locking, 26
- P**
- Pipe and ventilation connections, 16
  - Adjusting ventilation, 20
  - Cold and hot water, 18
  - Connecting cold and hot water, 18
  - Connecting the climate system, 18
  - Dimensions and pipe connections, 17
  - Exhaust air duct, 20
  - General pipe connections, 16
  - General ventilation connection, 20
  - Heating medium side, 18
  - Installation alternative, 19
  - Maximum boiler and radiator volumes, 16
  - Pipe dimensions, 17
  - Setting out dimensions, 17
  - Symbol key, 18
  - System diagram, 16
  - Ventilation flow, 20
- Pipe dimensions, 17
- Possible selection for AUX inputs, 29
- Possible selection for AUX output (potential free variable relay), 30
- Power connection, 23
- Preparations, 32
- R**
- Remove parts of the insulation, 13
- Removing the cover, base board, 22
- Removing the cover, immersion heater circuit board, 22
- Removing the covers, 13
- Removing the hatch, input circuit board, 22
- Room sensor, 25
- S**
- Safety information
  - Handling, 4
  - Inspection of the installation, 11
  - Marking, 4
  - Safety precautions, 4
  - Serial number, 10
  - Symbols, 4
  - Symbols on F370, 4
- Safety precautions, 4
  - Collection, 8
  - Decommissioning, 7
  - Filling, 7
  - Leak testing, 6
  - Marking, 8
  - Removal and draining, 7
  - Repairing sealed components, 6
  - When working in the refrigerant circuit, 9
  - Wiring, 6
- Scroll through the windows, 41
- Selecting menu, 40
- Selecting options, 40
- Serial number, 10
- Service, 49
  - Service actions, 49
- Service actions, 49
  - Draining the climate system, 49
  - Draining the hot water heater, 49
  - Helping the circulation pump to start, 50
  - Standby mode, 49
  - Temperature sensor data, 50
  - USB service outlet, 51
- Setting a value, 40
- Setting out dimensions, 17
- Settings, 26
- Standby mode, 49
  - Power in emergency mode, 26
- Start guide, 33
- Start-up and inspection, 33
  - Commissioning without fan , 34
  - Setting the pump speed, 35
  - Setting the ventilation, 34
- Status lamp, 38
- Supplied components, 13
- Switch, 38
- Switch for "Smart Grid ready", 29
- Switch for external blocking of addition and/or compressor, 29
- Switch for external blocking of heating, 29–30
- Symbol key, 18
- Symbols, 4
- Symbols on F370, 4
- System diagram, 16
- T**
- Technical data, 56
  - Dimensions and setting-out coordinates, 56
  - Electrical circuit diagram, 63
  - Technical Data, 57
- Technical Data, 57
- Temperature limiter, 21
  - Resetting, 21
- Temperature sensor data, 50
- The heat pump design, 14
  - Component locations, 14
  - List of components, 15
- Transport, 12
- Troubleshooting, 53
- U**
- USB service outlet, 51
- Use the virtual keyboard, 41
- V**
- Ventilation flow, 20
- Venting the climate system, 32





# Contact information

- AT** **KNV Energietechnik GmbH**, Gahberggasse 11, AT-4861 Schörfling  
Tel: +43 (0)7662 8963 E-mail: mail@knv.at www.knv.at
- CH** **NIBE Wärmetechnik c/o ait Schweiz AG**, Industriepark, CH-6246 Altishofen  
Tel: +41 58 252 21 00 E-mail: info@nibe.ch www.nibe.ch
- CZ** **Druzstevni zavody Drazice s.r.o.**, Drazice 69, CZ - 294 71 Benátky nad Jizerou  
Tel: +420 326 373 801 E-mail: nibe@nibe.cz www.nibe.cz
- DE** **NIBE Systemtechnik GmbH**, Am Reiherpfahl 3, 29223 Celle  
Tel: +49 (0)5141 7546-0 E-mail: info@nibe.de www.nibe.de
- DK** **Vølund Varmeteknik A/S**, Member of the Nibe Group, Brogårdsvej 7, 6920 Videbæk  
Tel: +45 97 17 20 33 E-mail: info@volundvt.dk www.volundvt.dk
- FI** **NIBE Energy Systems OY**, Juurakkotie 3, 01510 Vantaa  
Tel: +358 (0)9-274 6970 E-mail: info@nibe.fi www.nibe.fi
- FR** **NIBE Energy Systems France Sarl**, Zone industrielle RD 28, Rue du Pou du Ciel, 01600 Reyrieux  
Tel : 04 74 00 92 92 E-mail: info@nibe.fr www.nibe.fr
- GB** **NIBE Energy Systems Ltd**, 3C Broom Business Park, Bridge Way, S419QG Chesterfield  
Tel: +44 (0)845 095 1200 E-mail: info@nibe.co.uk www.nibe.co.uk
- NL** **NIBE Energietechnik B.V.**, Postbus 634, NL 4900 AP Oosterhout  
Tel: 0168 477722 E-mail: info@nibenl.nl www.nibenl.nl
- NO** **ABK AS**, Brobekkveien 80, 0582 Oslo, Postadresse: Postboks 64 Vollebakk, 0516 Oslo  
Tel: +47 23 17 05 20 E-mail: post@abkklima.no www.nibeenergysystems.no
- PL** **NIBE-BIAWAR Sp. z o. o.** Aleja Jana Pawła II 57, 15-703 BIALYSTOK  
Tel: +48 (0)85 662 84 90 E-mail: sekretariat@biawar.com.pl www.biawar.com.pl
- RU** © "EVAN" 17, per. Boynovskiy, RU-603024 Nizhny Novgorod  
Tel: +7 831 419 57 06 E-mail: kuzmin@evan.ru www.nibe-evan.ru
- SE** **NIBE AB Sweden**, Box 14, Hannabadsvägen 5, SE-285 21 Markaryd  
Tel: +46 (0)433 73 000 E-mail: info@nibe.se www.nibe.se

For countries not mention in this list, please contact Nibe Sweden or check [www.nibe.eu](http://www.nibe.eu) for more information.

NIBE AB Sweden  
Hannabadsvägen 5  
Box 14  
SE-285 21 Markaryd  
info@nibe.se  
www.nibe.eu

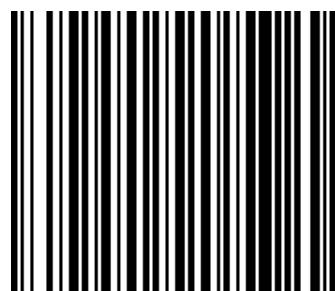

431424