

User manual
AG-WL10
Indoor unit air/air heat pump

Table of Contents

1	Important information	5
	Installation data	5
	Safety information	6
	Serial number	7
	AG-WL10 – an excellent choice	8
	Safety instructions	9
	Recovery	10
2	Design	11
3	Remote control	13
	Before use	13
	Overview	15
	Remote control display	17
	Function without remote control	19
4	Function modes	20
	Cooling	20
	Heating	21
	Automatic mode heat/cooling	22
	Dehumidification	25
	Ventilation	26
	Function in the event of power cut	26
5	Operating program	27
	TiO ₂ -air cleaning	27
	Night program/energy saving	27
	High power-program	27
	iFEEL/iFEEL C	28
6	Fan and air flow setting	29
	Selecting fan speed	29
	Airflow control	30
7	Clock and timer	32
	Setting the clock	32
	Setting the timer	32

Timer 1 hour _____	33
Vacation timer _____	34
8 Care and maintenance _____	35
Regular checks _____	35
Housing and grille _____	35
Air filter _____	36
Active carbon air filter _____	37
Advice for maximum comfort and lowest energy consumption ..	39
9 Disturbances in comfort _____	40
Troubleshooting _____	40
Fault codes _____	42
Item register _____	44

1 Important information

Installation data

Indoor unit	AG-WL10
Model designation	
Serial number (S/N)	
Installation date	
Installer	

Outdoor unit	
Model designation	
Serial number (S/N)	
Installation date	
Installer	

Serial number must always be given

Certification that the installation is carried out according to instructions in NIBE's installer manual and applicable regulations.

Date _____ Signed _____

Safety information

This appliance can be used by children aged from 8 years and above and persons with reduced physical, sensory or mental capabilities or lack of experience and knowledge if they have been given supervision or instruction concerning use of the appliance in a safe way and understand the hazards involved. Children shall not play with the appliance. Cleaning and user maintenance shall not be made by children without supervision.

Rights to make any design or technical modifications are reserved.

©NIBE 2017.

Symbols



NOTE

This symbol indicates danger to machine or person.



Caution

This symbol indicates important information about what you should observe when maintaining your installation.



TIP

This symbol indicates tips on how to facilitate using the product.

Serial number

The serial number can be found on the right-hand side of the indoor unit.

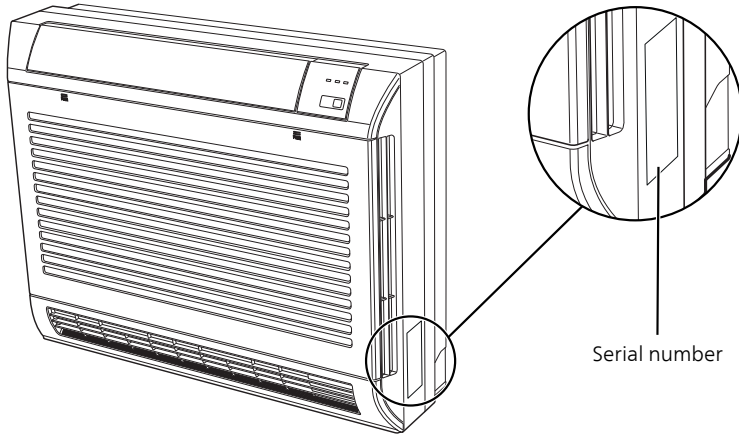

Caution

You need the product's (14 digit) serial number for servicing and support.

AG-WL10 – an excellent choice

AG-WL10 is part of a complete, modern heat pump system that offers effective technical energy saving and reduced carbon dioxide emissions. The integrated control system in the indoor unit gives safe and economical climate control.

The heat is retrieved from the outdoor air through an outdoor module where the refrigerant, which circulates in a closed system, transfers the heat from the heat source (outdoor air) to the indoor module (AG-WL10).

Excellent properties for AG-WL10:

- ***iFEEL***

The iFEEL function has been developed to obtain the best possible comfort. The iFEEL function uses the remote control's integrated temperature sensor to adjust the room temperature based on where the remote control is in the room. For best results the remote control should be positioned so that the communication line between the remote control and indoor unit is as direct as possible.

- ***Inverter controlled compressor***

The heat pump has an inverter controlled compressor that automatically adapts itself optimally and economically to your home's energy requirement.

- ***TiO₂-air cleaner***

AG-WL10 is equipped with a TiO₂ filter that effectively prevents bad odours and eliminates bacteria and microorganisms.

- ***Night program***

With the night program, the temperature and fan speed are adjusted to save energy without affecting the comfort of the premises.

- ***High power***

With the High Power function activated, the climate unit works at the maximum cooling or heating power.

Safety instructions

Read this instruction manual carefully before using the climate unit. If you are in any doubt or are experiencing problems, please consult your dealer.

This climate unit has been designed to create ideal climate conditions in your room. Only use the unit for this purpose and as described in this manual.

NOTE

- Avoid the use and storage of flammable liquids near the climate unit.
- Never install electric equipment that does not have IPX1 protection (protection against vertical water drops), under the unit.
- Do not switch the climate unit on or off using the main switch. Always use the ON/OFF button on the remote control or the function selector on the unit.
- Do not allow children to play with the climate unit.
- Do not cool the room too much if there are young children or disabled people in the room.
- The climate unit is not intended for use by persons (including children) with reduced physical, sensory or mental capabilities, or lack of experience or knowledge, unless they have been instructed by, or are under the supervision of, a person who is responsible for the safety of the climate unit when it is in use.

The manufacturer assumes no liability, if safety the standards or protection preventive measures are not complied with.

Recovery

Information about correct recycling of the product in accordance with the EU directive 2012/19/EU



Do not dispose of used units with normal household waste.

It must be disposed of at a special waste station or dealer who provides this type of service.

Separate waste sorting of an electrical and electronic device makes it possible to prevent adverse effects on the environment and human health, which may occur from inappropriate waste sorting and this also makes it possible to reuse and recycle the material, which leads to a considerable saving of energy and resources.

To emphasize the need for waste sorting and separate handling of these units, there is a symbol of a crossed-out waste bin on the product.

Improper disposal of the product by the user results in administrative penalties in accordance with current legislation.

Information about handling used batteries in accordance with the EU directive 2006/66/EC



Do not dispose of used batteries with household waste.

They must be disposed of at a special waste station or at a dealer who provides this type of service.

Separate disposal of batteries makes it possible to prevent adverse effects on the environment and human health, which may occur from inappropriate waste handling and this also makes it possible to reuse and recycle the material, which leads to a considerable saving of energy and resources.

To emphasize the need for waste sorting and separate handling of batteries, there is a symbol of a crossed-out waste bin on the product.

Improper disposal of the product by the user results in administrative penalties in accordance with current legislation.

2 Design

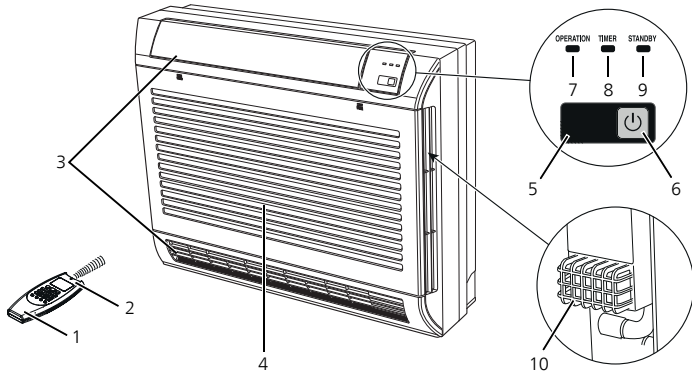

1. **Remote control**
2. **Temperature sensor:** The sensor registers the room temperature and controls the indoor unit accordingly.
3. **Air outlet:** The outlet spreads the treated air in the premises.
4. **Air intake:** The room air is drawn in and passes through the filter that eliminates the dust.
5. **Receiver:** It receives signals sent from the remote control.
6. **Function selector:** Press this button to toggle from one function to another (OFF, COOL and HEAT).

NOTE

The OFF position does not cut the mains supply. Use the main switch to cut the power supply to the unit.

7. **Function lamp:** This lamp lights when the unit is in use. It flashes once to indicate that the command from the remote control has been received.
8. **Timer lamp:** This lamp goes on when the system is being controlled by the timer.
9. **Standby lamp:** This lamp goes on when the unit is powered and awaiting a command from the remote control.
10. **Temperature and moisture sensor:** If the remote control sensor is not used the indoor unit sensor is activated, which registers the room temperature and humidity and controls the indoor unit accordingly.

**TIP**

The climate unit can be set so that all indicator lamps are always off, even during operation. Perform the following on the remote control:

- Select TiO₂ air cleaner() **OFF**.
- At the same time, press  and  for five seconds. Repeat the procedure to reset to normal mode.

In all fault situations, as read by the climate unit's fault detection system, the indicator lights activate, even if they are set to be off, according to the fault to be indicated. See section "Fault codes" on page 42 for more information.

3 Remote control

Before use



TIP

If you wish to install more than one unit in the same space it is possible to use the same remote control for all units.

You can also use the remote control for a specific unit. See the installer manual for more information about coding the remote control.

- Remove the cover from the back of the remote control and check that the six microswitches have been set as in the figure below:

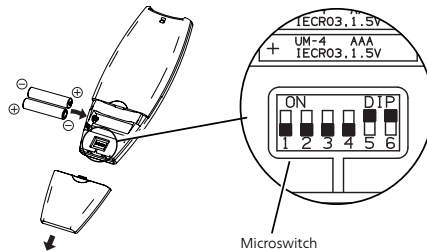

The remote control can also be controlled by wire. For more information see the installer manual.

NOTE

The remote control is set with default code 1 and does not usually have to be changed.

If more than one unit is installed in the same room, code the units 1 - 4 with the remote control (see the procedure in the installer manual).

- Insert two AAA 1.5 V-DC alkaline batteries and follow the polarity indicated on the remote control. The time indicator on the display flashes.
- Press the ST button and set the time. The remote control is now ready for use.

The batteries last longer than six months depending on how often the remote control is used. Remove the batteries if the remote control is not used for long periods of time (longer than one month). Replace the batteries when the indicator lamp for data transfer () on the remote control flashes or when the climate unit does not respond to the remote control command.

The remote control batteries contain hazardous substances. When they reach the end of their life, they must be disposed of in accordance with applicable legislation.

Removing batteries

- Remove the cover.
- Slide the battery towards the negative terminal and pull it out from the positive terminal's side (as shown in the figure).
- Remove the other battery in the same way.

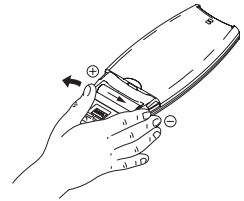

Overview

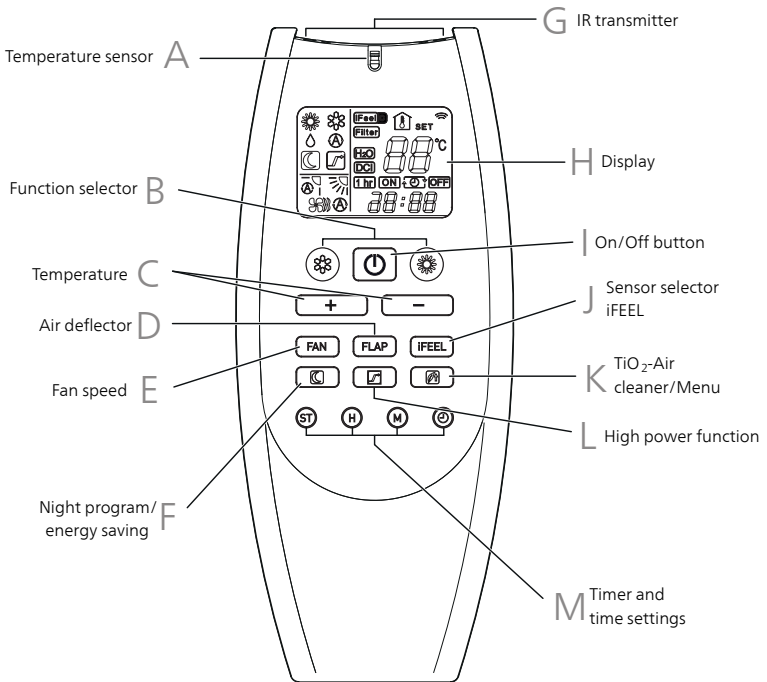

A Temperature sensor

A sensor inside the remote control that reads off the room temperature.

B Function selector

Change the climate unit's function using these buttons.

C Temperature

The temperature buttons are used to increase/reduce the temperature.

D Air deflector

Use the air deflector to adjust the air distribution.

E Fan speed

The fan button is used to select the fan speed between automatic mode or three set speeds (low - high).

F Night program/energy saving

Press this button to select the "Night program/ECO" function. Read more about the function on page 27.

G IR transmitter

The IR transmitters transmit the command to the climate unit's receiver.

H Display

The display shows operating information when the remote control is on.

I On/Off button

Starts or stop the climate unit.

J Sensor selector iFEEL

Use iFEEL to adjust the room temperature according to the remote control position. Read more on page 28.

K TiO₂ air cleaner/menu

The TiO₂ air cleaner button is used to:

- Activate the "Air cleaning" function.
- Enter the menu functions.

L High power function

The High power function maximises the climate unit's heating or cooling power. Read more on page 27.

M Timer and time settings

Use these buttons to change the timer and time settings.

Remote control display

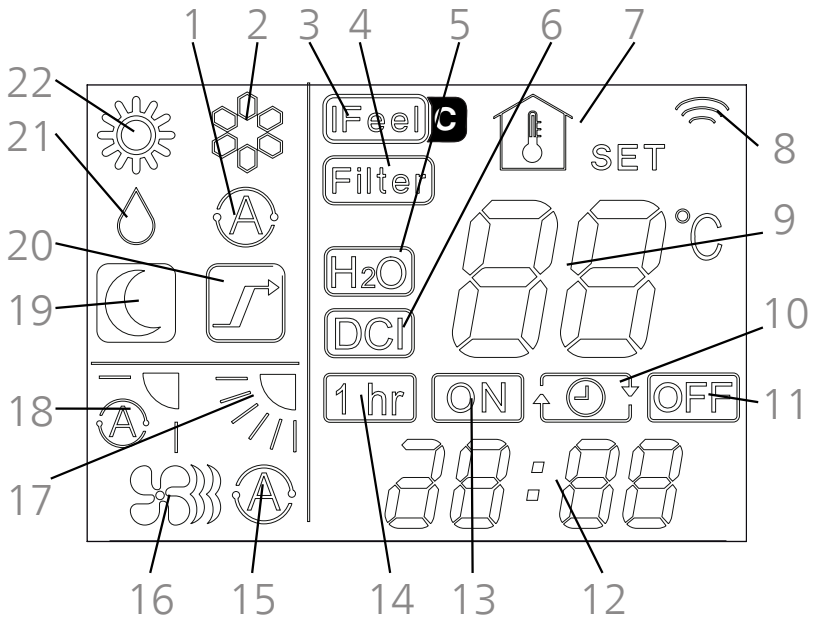

- 1 Automatic operating mode selection
- 2 Operating mode cooling
- 3 iFEEL/iFEEL C function active
- 4 Air ioniser active
- 5 No function on this model
- 6 No function on this model
- 7 Indicates that the set temperature is displayed, otherwise the present room temperature is displayed
- 8 Transfer of data in progress
- 9 Temperature

- 10** Daily timer
- 11** Timer stop time
- 12** Clock/Clock for setting timer functions
- 13** Timer start time
- 14** Timer 1 hour selected
- 15** Automatic fan speed
- 16** Manual fan speed
- 17** Manual air direction
- 18** Automatic air direction
- 19** Night reduction
- 20** High power function
- 21** Operating mode dehumidifying.
- 22** Operating mode heating

Function without remote control



Caution

If communication between the remote control and indoor unit is interrupted, the temperature is controlled by the indoor sensor. In these cases the temperature around the remote control differs from that registered by the indoor unit.

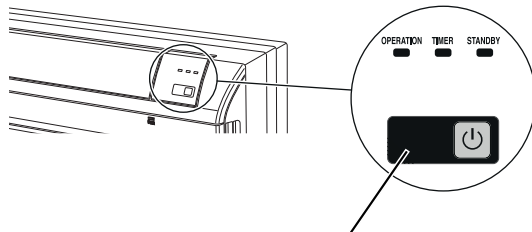

Function selector

If the remote control does not work or is missing, use the function selector as follows:

If you want to start the climate unit, press the function selector to select the desired mode. Press once to activate cooling mode, twice to activate heating mode and three times to switch off the unit, etc.

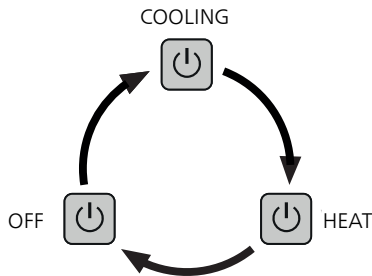

NOTE

The climate unit starts with the fan at HIGH speed. The temperature is set to 25 °C for cooling mode and to 21 °C for heating.



4 Function modes

Cooling



NOTE

Check that the unit is connected to the mains supply and that the function lamp is lit.

1. Press button  until the symbol for cooling () appears on the display.
2. Press the +/- button (temperature selection) to set the desired temperature (the setting range can be set between 10 °C and 32 °C).



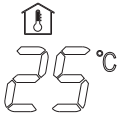

The display indicates the selected temperature value.



Once five minutes have passed after setting the desired temperature, the display resumes to showing the room temperature.

3. Press the **FAN** button to set the fan speed.

Heating

1. Press button  until the symbol for heating () appears on the display. If the symbol lights stays lit the fan stops at the achieved, desired temperature. If it flashes, the fan is running even after the desired temperature has been reached. This function allows heat distribution if a stove or other external heating source is installed near the indoor unit.
2. Press the +/- button (temperature selection) to set the desired temperature (the setting range can be set between 10 °C and 32 °C).



The display indicates the selected temperature value.



Once five minutes have passed after setting the desired temperature, the display resumes to showing the room temperature.

3. Press the **FAN** button to set the fan speed.

NOTE





After the heating function is activated, the fan stops. This is because the "Prevention of cold air" function is active and activates the fan's normal function, only after the indoor unit's heat exchanger is sufficiently warm. During this period the function lamp stays lit (red lamp).

Defrosting the outdoor unit's heat exchanger

When the outdoor temperature drops below zero on the external heat exchanger, ice builds-up that reduces the heating output. When this occurs, a function activates that defrosts the heat exchanger. In these operating conditions, the internal fan stops. The heating function resumes after a few minutes, depending on the room and outdoor temperature.

Automatic mode heat/cooling

When the "Automatic" mode is activated the climate unit automatically chooses between cooling and heating to maintain the set temperature.

1. Press the  or  button until the auto icon () appears on the display (even the symbol  or  appears).
2. Press the +/- button (temperature selection) to set the desired temperature (the setting range can be set between 10 °C and 32 °C).



The display indicates the selected temperature value.



Once five minutes have passed after setting the desired temperature, the display resumes to showing the room temperature.

3. Press the  button to set the fan speed.

Example: function diagram in auto mode (Ⓐ) with room temperature set to 23 °C:

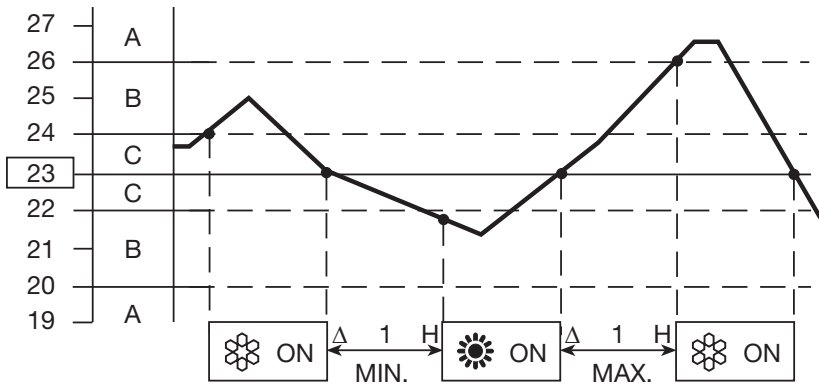

NOTE

The climate unit changes function mode (from heating to cooling or vice versa) when one of the following occurs:

- ZONE A: changes if the temperature varies by at least 3 °C from the value set on the remote control.
- ZONE B: changes if the temperature varies by at least 1 °C from the value set on the remote control one hour after the compressor has stopped.
- ZONE C: never changes if the temperature does not vary by more than 1 °C in relation to the value set in the remote control.

Automatic mode in multisplit systems



When the climate unit is part of a multisplit system with more than one indoor unit, automatic mode functions in the following way:

- The first unit that is started determines which mode (heating/cooling) the subsequent units in the system will have.
- If the system is in cooling mode and a unit is activated in heating mode that unit transmits an error message (wrong operating mode). If the same unit is in automatic mode and the desired temperature in the room is lower than the actual temperature, the unit will operate in cooling mode, like the system's other units. If the actual temperature should be too high, the unit operates in ventilation mode.
- If the system is in heating mode and a unit is activated in cooling mode that unit transmits an error message (wrong operating mode). If the same unit is in automatic mode and the desired temperature in the room is higher than the actual temperature, the unit will operate in heating mode, like the system's other units. If the actual temperature should be too low, the unit operates in ventilation mode.

		The indoor unit that is started first				
		AUTO	HEAT	DEHU-MIDIFY-ING	COOL-ING	FAN
Sub-sequent indoor units	AUTO	-	-	-	-	-
	HEAT	-	OK	-	-	OK
	DEHU-MIDIFY-ING	-	-	OK	OK	OK
	COOLING	-	-	OK	OK	OK
	FAN	-	OK	OK	OK	OK

Dehumidification

The dehumidification is controlled by the difference between the desired and the actual room temperature and by the room's relative humidity.

1. Press button  until the symbol for dehumidifying () appears on the display.
2. Press the +/- button (temperature selection) to set the desired temperature (the setting range can be set between 10 °C and 32 °C).



The display indicates the selected temperature value.

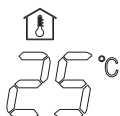



Once five minutes have passed after setting the desired temperature, the display resumes to showing the room temperature.

- When the room temperature is above the set value the heat pump works automatically to dehumidify as effectively as possible.
- When the room temperature is below the set value, the heat pump still works at low power to continue dehumidification and can reduce the room temperature in small spaces to 10 °C.

NOTE

- Use the dehumidification function to reduce the air humidity in the room.
- When the room temperature reaches the set value, the climate unit repeats on and off cycles in automatic mode.
- In dehumidifying mode the fan speed is set automatically.
- The defrosting function does not work at room temperatures below 10 °C.

Ventilation



If only air circulation is required in the premises, without changing the temperature, press the  button until the fan symbol () appears in the display. The fan speed is controlled by the  button.

Function in the event of power cut

The climate unit stops in the event of a power cut. When the electrical supply is restored, the climate unit restarts automatically after three minutes.

5 Operating program

TiO₂-air cleaning





Press the button  (the symbol  is shown on the display) to activate TiO₂ - the air cleaner that effectively prevents odours and eliminates bacteria and microorganisms.

NOTE

The device is only active if the inner fan is working.

Night program/energy saving

If the night program is selected, the climate unit automatically changes the set temperature 60 minutes after selection. In this way, energy is saved without risking the comfort of the premises. During the night program, the fan speed is automatically reduced making it quieter.

1. Press the  button or  to set the climate unit for cooling, dehumidifying or heating.
2. Press the  button. The  symbol appears in the display.
3. To exit the program, press  again.

Function mode	Temperature change
Heating	Reduces by 2 °C
Cooling and dehumidifying	Increases by 1 °C

High power-program

When this option is active, the fan speed is set automatically and the climate unit works at full cooling or heating power. High Power is active until this function is switched off using the HIGH POWER button.

NOTE

In HIGH POWER mode, the temperature of the premises may not correspond with the set temperature.

iFEEL/iFEEL C



TIP

iFEEL C is not available on this model. When selected, the function becomes the same as iFEEL.

In the remote control there is a iFEEL sensor that makes it possible to adjust the temperature based on where in the room the remote control is located, for optimum comfort. The iFEEL function works via signal transfer from the remote control to the indoor module, via two transmitters with IR LEDs. The LEDs have a large scatter angle, which gives good room coverage. Therefore, the remote control seldom needs pointing directly at the indoor module, which is usually the case with remote controls, e.g. TVs and consumer electronic products. However, the IR signal can be interrupted or partially absorbed by different environmental factors, e.g.:

- fluorescent lighting
- sunlight
- high humidity
- IR generated heat sources
- presence of many people or animals
- certain building, interior and furniture material
- size and shape of structures and objects in the environment
- reflection and/or partial absorption of the IR signal

It is therefore appropriate to position the remote control so that the communication line between the remote control and indoor unit is as direct as possible. If correct signal transfer is not possible, adjust the temperature from the indoor module's sensor.

In such cases, the desired temperature (set temperature) can deviate from the temperature shown on the remote control, due to the stratification of the air in the room (cooler air near the floor and warmer near the ceiling), especially if the indoor unit is wall mounted.

Hot air rises. When iFEEL is disconnected, or the remote control cannot be read by the indoor unit, such stratification can cause the indoor module to detect a high temperature that only exists locally, and, therefore, appears to regulate incorrectly.

In such cases, simply increase the set desired temperature on the remote control until the actual temperature is comfortable.

6 Fan and air flow setting

Selecting fan speed

Automatic mode

Set automatic fan mode () using the **FAN** push button. The micro-processor automatically controls the fan speed. When the climate control starts to work, in heating or cooling mode, the fan speed varies (low-high) in accordance with the room temperature.



NOTE

The automatic speed cannot be selected in function mode "ventilation".

Manual mode

To manually regulate the fan speed, press the **FAN** button and select the desired speed:



Low speed



Medium speed



High speed

Airflow control

Horizontal (manual)

This climate unit is equipped with two fans; one behind the upper grille and the other behind the lower grille.

The air flow can be regulated horizontally by moving the control as illustrated.

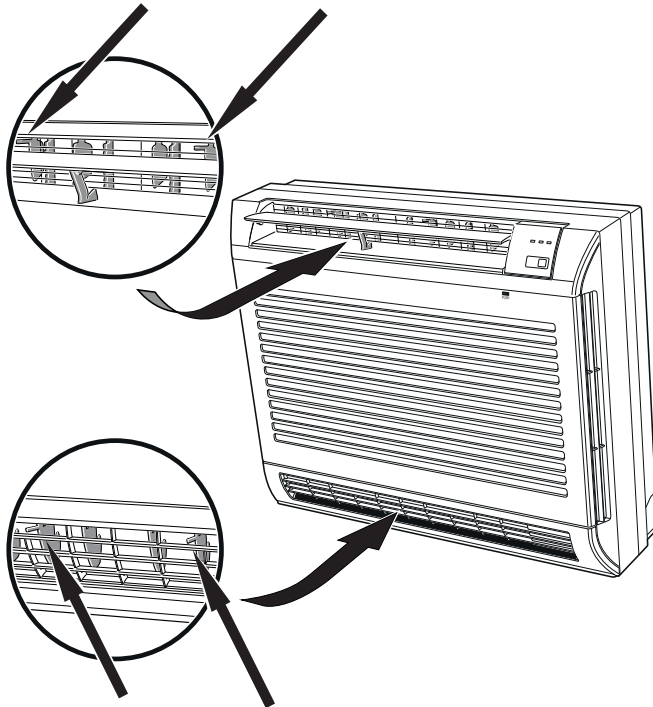

Caution

If the installation is in automatic operating mode with both fans activated the lower fan works most when heating and the upper fan when cooling.

Vertically (with remote control)

Check that the remote control is on. Press the FLAP button to select the desired function.



TIP

It is just the unit's upper fan that can be adjusted vertically.

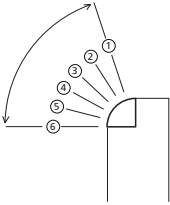

Air direction in auto mode. The air direction can also be fixed in the six modes.

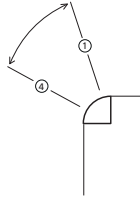

Air direction in cooling and dehumidifying mode.

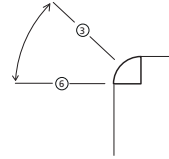

Air direction in heating mode.



NOTE

- The air deflector closes automatically when the system is switched off.
- When the system starts in heating mode, the fan stops and the air deflector is in position 4 (if it is set to automatic oscillation) until the system starts to heat up. When the air is heated, the position and speed of the air deflector changes according to the settings specified on the remote control.

7 Clock and timer

Setting the clock

1. Press the ST button three times. The time indicator starts to flash.
2. Press button H until the desired hour is shown. Press button M until the desired minutes are shown. The time indicator on the display stops flashing automatically after 10 seconds.

Setting the timer

Start time (ON)



- Press the ST button once. The ON indicator and the time indications start to flash.
- Press button H until the desired hour is shown. Press button M until the desired minutes are shown. The indicator on the display returns to indicating the current time after 10 seconds.
- Press the ON/OFF button to start the climate unit.
- Press the Ⓢ button to set the timer to the ON TIME (start) function.

Stop time (OFF)

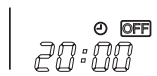

- Press the ST button twice. The OFF indicator and the time indications start to flash.
- Press button H until the desired hour is shown. Press button M until the desired minutes are shown. The indicator on the display returns to indicating the current time after 10 seconds.
- Press the ON/OFF button to start the climate unit.
- Press the Ⓢ button twice to set the timer to the "OFF TIME" (stop) function.

Daily timer (ON/OFF)



- Set the timer as illustrated in the section above.
- Press the ON/OFF button to start the climate unit.
- Press the ⏸ button three times to set the timer's program on/off.

NOTE

After the timer has been set, press the ST button to check the set on/off time (ON/OFF).

Timer 1 hour

This function activates the climate unit for one hour, according to the set conditions and then switches it off, regardless of whether the climate unit was on or off before.

Actions for setting the timer

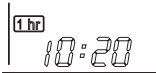

- Press the ⏸ button four times. The display shows the symbol for TIMER 1 HOUR.

Resetting the timer

- Press the ON/OFF button to switch off the climate unit.
- Wait until the inner unit is off.
- Press the ON/OFF button again to restart the climate unit.

Vacation timer

The "vacation timer" functions makes it possible to activate the indoor unit, with a programmable delay of up to 99 days regarding the functions of the daily timer, On-timer, Off-timer (does not apply to TIMER 1 HOUR) as previously described in this manual. With this function it is possible to program a climate unit restart after a public holiday, a vacation of one or two weeks etc. This timer works as follows:

- **Start time:**

After x number of days, the climate unit starts with the set values and continues until another setting is made.



- **Stop time:**

The climate unit runs according to settings in x number of days, it then stops.

- **Daily timer:**

First set times in "daily timer". After x number of days, the machine starts and runs according to the timer settings each day until another setting is made.

To activate the function, follow the steps below in order:

1. Hold the  button in on the remote control for at least 6 – 7 seconds. When the button is released, the menu for selecting the number of days the delay is to apply for appears.
2. Select desired timer (daily timer, start time, stop time) and press the same button .
3. Set the desired number of delayed days using "+".
4. Hold the  button in on the remote control again for at least 6 – 7 seconds. When the button is released, you are returned to the normal menu on the remote control.

The icon for the desired timer now starts to flash and the corresponding timer activates, according to the set number of days delay.

8 Care and maintenance

Regular checks

Your heat pump is, in principle, maintenance free and therefore requires minimal care after commissioning. On the other hand, it is recommended that you check your installation regularly.

If something unusual occurs, messages about the malfunction appear in the display in the form of alarm codes on the indoor unit display. See error code table on page 42.



NOTE

- Aside from regular cleaning, maintenance actions must be performed by service technicians.
- Check that the climate unit is off and that the mains supply is disconnected, before carrying out further cleaning work.
- Do not pour water onto the indoor unit during cleaning. This can damage the internal parts of the unit and cause short-circuits.

Housing and grille

Clean the inner casing and grille of the unit with a vacuum cleaner brush, or with a soft and dry cloth. If there are any spots on these parts, use a damp cloth with a small amount of cleaning agent.



Caution

- Do not use any solvents, cleaning agents or strong chemical substances. Do not use boiling water to clean the indoor unit.
- Some metal edges and fins on the climate unit are sharp. Take great care when cleaning these.
- The heat exchanger and other components on the outdoor unit must be cleaned at least once a year. Contact installer.

Air filter

The air filter behind the front panel should be cleaned at least once every other week.

Never use a naked flame or a hairdryer to dry the filter, this is to prevent deformation or fire.

NOTE

Take care when handling the filter as sharp objects can damage it.

Removing the filter

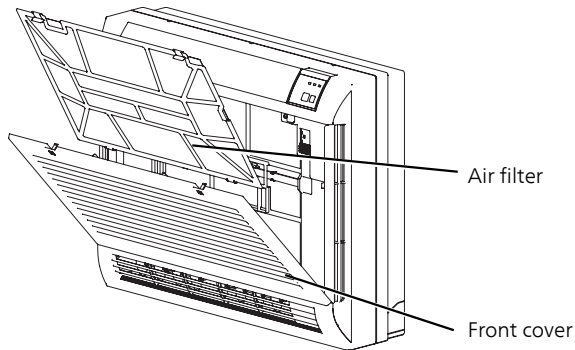

1. Press the "Push" markings at the top of the front cover and fold it out.
2. Unhook the filter and clean it.

Cleaning the filter

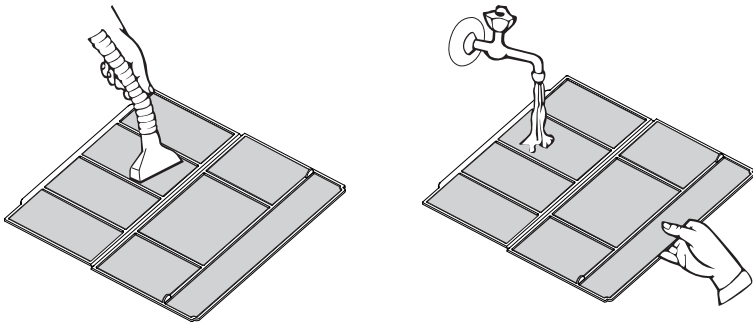

Clean the filter using a vacuum cleaner. In the event of oily dust, wash with warm soapy water, rinse and allow to dry.

Active carbon air filter

The activated carbon air filter can be used as a complement to the standard filter. The filter effectively removes dirt and prevents bad odours.

NOTE

The activated carbon air filters are stored in polythene bags. For optimum function, the bags should not be opened until the filters are to be installed.

NOTE

This filter does not ventilate the room air and does not remove dangerous gases or vapour. If gas or oil heating equipment is used, doors or windows must be regularly opened.

Installing activated carbon air filter

The activated carbon air filter is installed behind the air filter.

1. Remove the air filter.
2. Install the activated carbon air filter as illustrated below.
3. Reinstall the air filter.

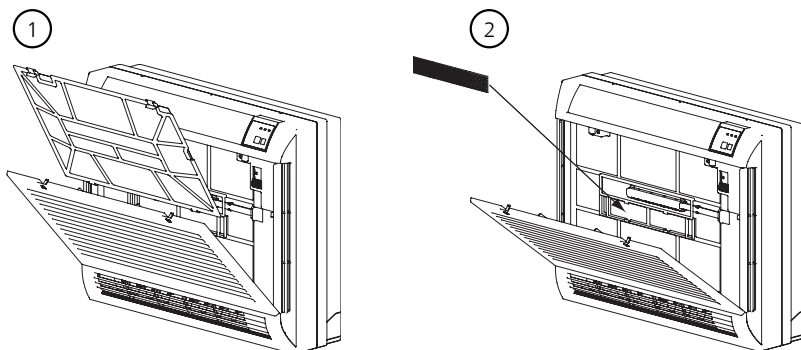

Replacing the activated carbon air filter

- The activated carbon air filters are single use filters.
- Do not discard the frame around the filter.

- A used filter cannot be reused, even after cleaning.
- Purchase a replacement filter from the nearest dealer.
- Check the condition of the filters every other week.
- Replace the filter every six months.

Advice for maximum comfort and lowest energy consumption

Avoid:

- To block the exhaust and intake grilles on the unit, if they are blocked the function is impaired and damage may be caused.

Check:

- That the filter is always clean. A dirty filter reduces the air exchange and reduces the unit's capacity.
- That doors and windows are closed to prevent non-conditioned air from entering.

9 Disturbances in comfort



Caution

Do not use mobile telephones in the proximity of the climate unit as this can interfere with the normal function of the unit. If this problem occurs (the OPERATION lamp goes on, but the climate unit does not work), reset normal function by disconnecting the mains supply for approx. 3 minutes using the main switch or plug. Now start the climate unit again.



NOTE

Work behind covers secured by screws may only be carried out by, or under the supervision of, a qualified installation engineer.



Caution

You need the product's (14 digit) serial number for servicing and support.

Troubleshooting

If the climate unit does not work normally, perform the following checks, before contacting the installer.

The climate unit does not work at all

Possible cause	Action
Mains supply interrupted.	Reset mains supply.
Circuit fuse blown or faulty.	Contact installer.
The start button is set to "OFF".	Press the start button "ON/OFF".
Discharged remote control batteries.	Replace the batteries.

The climate unit does not cool or heat sufficiently

Possible cause	Action
Dirty or blocked filter.	Clean the filters.
Too high a temperature (further heat source or too many people in the room).	Remove or switch off other heat sources.
Doors or windows are open.	Close doors and windows.
The air flow is blocked by external object.	Remove blockages to resume correct air circulation.
Too high a temperature set on remote control.	Change the set temperature on the remote control.
Very low outdoor temperature.	Use another auxiliary heat source.
The defrosting system on the outdoor unit during heating does not work.	Contact installer.

The climate unit emits a clicking noise

Possible cause	Action
During the function the plastic parts expand as the temperature varies, which causes the unpleasant noise.	Situation that must be deemed normal. The clicking noise disappears when the temperature stabilises.

The climate unit's display does not light up

Possible cause	Action
The display has been switched off from the remote control.	On the remote control: Select filter (), OFF, at the same time press the IFEEL and FAN buttons with the remote control pointing towards the indoor unit. Release the buttons after approx. five seconds.

Fault codes



Indoor unit

In most cases, the heat pump notes a malfunction and indicates this with an alarm via the LED lamps.





















NOTE

In the event of a problem that does not have an action description, contact your installer.

Key to symbols

-  The LED does not come on
-  The LED lights continuously
-  The LED flashes

Automatic diagnosis

LED lamps			Cause/action
OPERATION	TIMER	STANDBY	
			<ul style="list-style-type: none"> ■ The unit has not been addressed for the multisplit system, allocate the unit an address with the remote control (see the installer manual). ■ The operating mode selected does not correspond with the one that is active in the multisplit system (heating mode is selected when the rest of the system is in cooling mode or vice versa). Change to the operating mode that is active in the multisplit system. <p>If the fault persists after the above steps, contact the installer.</p>
			Problem with the outdoor unit.
			Communication problems between the indoor and outdoor units.
			Faulty heat exchanger sensor on the indoor unit.
			Faulty room sensor on the indoor unit.
			Fault in the fan motor.
			Faulty combination of indoor and outdoor units.

Outdoor unit

To troubleshoot the outdoor unit, see section "Disturbances in comfort" in the installation manual for the outdoor module.

10 Item register

A

- Air filter, 36
- Airflow control, 30
- Automatic mode heat/cooling, 22

C

- Care and maintenance, 35
 - Air filter, 36
 - Housing and grille, 35
 - Regular checks, 35
- Clock and timer, 32
 - Daily timer, 33
 - Start time, 32
 - Stop time, 32
 - Timer 1 hour, 33
 - Vacation timer, 34
- Cooling, 20

D

- Dehumidification, 25
- Disturbances in comfort, 40
 - Fault codes, 42
 - Troubleshooting, 40

F

- Fan and airflow settings, 29
 - Airflow control, 30
 - Fan speed, 29
- Fan speed, 29
- Fault codes, 42
- Function in the event of power cut, 26
- Function modes, 20
 - Automatic mode heat/cooling, 22
 - Cooling, 20
 - Defrosting, 21
 - Dehumidification, 25
 - Function in the event of power cut, 26
 - Heating, 21
 - Ventilation, 26
- Function without remote control, 19

H

- Heating, 21
- High power-program, 27

I

- iFEEL/iFEEL C, 28

Important information, 5

- AG-WL10 – an excellent choice, 8
- Installation data, 5
- Recovery, 10
- Safety information, 6
- Serial number, 7
- Indoor unit's design, 11
- Installation data, 5

N

- Night program/energy saving, 27

O

- Operating program, 27
 - High power-program, 27
 - iFEEL/iFEEL C, 28
 - Night program/energy saving, 27
 - TiO₂-air cleaning, 27

R

- Remote control, 13
 - Before use, 13
 - Overview, 15
- Remote control display, 17

S

- Serial number, 7

T

- TiO₂-air cleaning, 27
- Troubleshooting, 40

V

- Ventilation, 26

37 4254 079 02

NIBE AB Sweden
Hannabadsvägen 5
Box 14
SE-285 21 Markaryd
info@nibe.se
www.nibe.eu

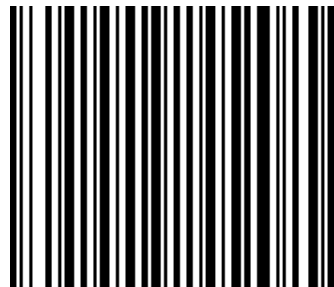

331830